



Table of Contents

1	Foreword	6
1.1	Appropriate usage	6
2	General information	7
2.1	Explanation of the symbols in the manual	7
2.1.1	Legend	7
2.2	Safety rules	7
2.2.1	Basic safety	7
2.2.2	General safety instructions	8
2.2.3	Safety instructions for the operator	8
2.2.4	Safety instructions for operating personnel	8
2.2.5	Instructions for safe transport	9
2.2.6	Safety during operation	9
2.2.7	Safety instructions for maintenance, repair and fault elimination	10
2.2.8	Safety during work on electrical system	10
2.2.9	Safety during work on pneumatic system	10
2.3	Warning signs	11
2.4	Safety devices	12
2.5	Purpose of use	14
2.6	Function	15
3	Technical data	16
4	Transport and setup	17
5	Connections and other preparations	18
5.1	Preparation for operation	18
5.1.1	Pneumatic system	18
5.1.1.1	Cut off compressed air	18
5.1.2	Coolant tank	18
6	Description of the operating elements	20
6.1	Operating elements operating panel	20
6.2	Operating elements ski magazine	21
6.3	Operating elements module PREGRIND	23
6.3.1	Adjustment of the grinding angle SEG	24
6.4	Operating elements module STONE	25
6.4.1	Adjustment of the grinding angle disc	26
7	Charging of the ski magazine	27
8	Load - save - delete grinding program	28
8.1	Load grinding program	28
8.2	Save grinding program	29
8.2.1	Save as	31
8.3	Delete grinding program	31

8.4	Program info	32
9	Working with the machine	33
9.1	Handling when working with the ski magazine	33
9.2	Handling when working without ski magazine	34
9.2.1	Grinding a snowboard	35
9.2.2	Grinding a cross-country ski	36
9.2.3	Grinding a ski with a width of between 135 and 180 mm.	37
9.2.4	Grinding a Rocker or V-Shape ski	39
10	Change grinding program	41
10.1	Automatic ski recognition	41
10.2	Tips for input fields	42
10.3	Adjustment sequence of operations	43
10.3.1	Selection of the processes	43
10.3.2	Adjust feed speed	45
10.3.2.1	Variable feed speed	45
10.3.2.2	Delete the sequence of operations	45
10.3.2.3	Variable holding-down pressures with the snowboard programs	46
10.4	Module PREGRIND - Change parameters	47
10.4.1	Parameters SEG	48
10.4.1.1	Detail parameters SEG	49
10.4.1.2	Manual functions SEG	50
10.4.2	Parameters belt unit	51
10.4.2.1	Detail parameters belt unit	52
10.4.2.2	Manual functions belt unit	53
10.5	Stone unit - change parameters	55
10.5.1	Reduce grinding force for children ski	55
10.5.2	Speed parameters	56
10.5.2.1	Detail parameters stone unit	57
10.5.3	Structure selection	59
10.5.4	Structure parameters	60
10.5.4.1	Chevron structure	63
10.5.4.2	Racing structures	65
10.5.4.3	Structure preview	66
10.5.5	Manual functions stone unit	67
10.5.6	Check and adapt stone diameter	68
10.6	Disc unit - change parameters	70
10.6.1	Disc parameters	71
10.6.1.1	Detail parameters disc unit	72
10.6.2	Manual functions disc unit	73
11	Variable grinding force	74
11.1	Changing the grinding force parameters	75
11.1.1	Copy - paste curve	75
12	General adjustment	76
12.1	Stop after x skis	77
12.2	Ski magazine return	77
12.3	Language selection	77
12.4	Change date, time and display brightness	78

12.5	Operating hours	79
12.6	Ski/board counter	80
12.7	Alarm history	81
12.8	Factory values	82
12.9	List of components	83
12.9.1	Password for component list	83
12.10	Ski measurements	83
12.11	Emulsion calculator	84
12.12	Automatic filling of the cooling lubricant tank (optional)	86
13	Overview adjustment parameters	87
13.1	Adjustment parameters module PREGRIND	88
13.2	Adjustment parameters module STONE	89
14	Maintenance - service	91
14.1	General	91
14.1.1	Cleaning the inside of the machine	91
14.1.2	Maintenance base machine - coolant tank - charging/discharging	92
14.1.3	Emergency release of the sliding doors	94
14.1.4	Clean laser	94
14.1.5	Battery change on the operating panel	95
14.1.6	General indications for proper dealing with lubricating coolant	96
14.2	Maintenance - service module PREGRIND	97
14.2.1	Changing the grinding belt SEG	97
14.2.2	Dressing the SEG belt	97
14.2.3	Changing the grinding belt of belt unit	98
14.2.4	Maintenance works	99
14.3	Maintenance - service module STONE	100
14.3.1	Changing the grinding stone	100
14.3.2	Changing the diamond	101
14.3.3	Changing the ceramic discs	102
14.3.4	Carry out test run according to official regulations	102
14.3.5	Maintenance works	103
14.4	Maintenance schedule	105
15	Shut-down and disposal	106
16	Declaration of Conformity	107

1 Foreword

These operating instructions must be read by the operators and by the persons responsible for the machine maintenance before initial use and serves as a supplement to the training documentation.

Damage caused by failure to follow the instructions herein will not be covered by the warranty. The user of this machine is legally bound to the casualty regulations of the country in question.

In addition, these operating instructions are confidential. It must only be accessible to authorized persons. Making it available to third parties requires the written approval of WINTERSTEIGER.

All documents are protected in accordance with copyright protection. The transfer and copying of these documents, even excerpts, and the utilization and communication of its content are not permitted, except if this was explicitly authorized in writing.

Noncompliance is punishable and establishes a compensation claim. All rights for the execution of commercial property rights are reserved by WINTERSTEIGER.

1.1 Appropriate usage

The machine was manufactured exclusively for normal use for ski service work (appropriate usage). Any other use is considered inappropriate. The manufacturer is not liable for any damage resulting from inappropriate use. The user takes full responsibility in such cases.

Appropriate usage includes following the operating, maintenance and repair provisions set out by the manufacturer. Any applicable accident prevention specifications and other generally accepted safety and medical regulations are also to be obeyed.

Any changes to the machine by the user renders manufacturer liability null and void with regards to any resulting damages.

We constantly try to improve our products and therefore reserve the right to make any changes or improvements we feel are appropriate. We are, however, not obligated to extend these changes or improvements to already delivered machines or devices.

All images, dimensions and weight specifications in the operating instructions are non-binding.

Original operating manual

© Copyright 2007 by



WINTERSTEIGER AG :: A-4910 Ried/I Dimmelstrasse 9

Tel. +43 7752 919-0

e-mail: office@wintersteiger.at

Author and graphics: Franz Badegruber

Design: Maria Marek-Pollhammer

2 General information

2.1 Explanation of the symbols in the manual



DANGER describes a danger with a high degree of risk, which will result in death or severe injury if it is not prevented.



WARNING describes a danger with a medium degree of risk, which could result in death or a severe injury if it is not prevented.



CAUTION describes a danger with a low degree of risk, which could result in small or moderate injury if it is not prevented.



This exclamation point refers to a possible damage or destruction of the product, the process and/or its environment.



Special information for the practical work or general recommendations can be found here.

2.1.1 Legend

Following abbreviations are used in this operating manual:

- SE = side edge
- BE = base edge
- SEG = Side edge grinder belt (with module PREGRIND)

2.2 Safety rules

2.2.1 Basic safety

- This machine was built according to the latest technology and generally accepted safety rules. However, risks for the user or third parties or damage to the machine and other material assets may occur during use if the machine:
 - is operated by untrained personnel without proper instructions,
 - is not used according to regulations,
 - is improperly repaired or maintained.

2.2.2 General safety instructions

- Connection of the device to the mains should only be carried out by an electrical engineer who knows the country-specific regulations of the local power supply companies exactly and adheres to them strictly.
- Observe correct supply voltage! Connected loads are visible on the type plate under the main switch. Check whether these values are in agreement with network voltage.
- The machine may only be operated with original WINTERSTEIGER spare parts or consumables. Any use of foreign material shall be at the risk of the operator and will invalidate the machine warranty. This especially applies to grinding emulsions and machine cleaners.
- Due to the high air humidity contents produced during the grinding process, adequate ventilation must be provided!!
- WINTERSTEIGER recommends using an emulsion filter for this machine.

2.2.3 Safety instructions for the operator

- In addition to the mandatory accident prevention and health & safety regulations in force in the place of use, generally accepted specialist rules for safe and professional work are to be observed.
- The employer is to ensure the operating personnel to wear personal protective equipment as this is prescribed by local regulations.
- First-aid equipment (first-aid box, etc.) is to be stored within reach! Location and operation of fire extinguishing equipment are to be specified. It is necessary to install fire detection and fire fighting systems.
- The operator/user of the machine must not carry out any alterations, additions or conversions on the machine that may impair safety without prior permission WINTERSTEIGER AG!
- Only employ trained or instructed personnel. Staff responsibilities for the operation, equipment, maintenance, and repair of the machine are to be clearly defined! A machine operator is to be selected who should be responsible for machine and personnel. Personnel that need training, instruction, or personnel unertaking in general training may only operate the machine under the constant supervision of an experienced skilled worker!

2.2.4 Safety instructions for operating personnel

- The operating instructions must constantly be accessible in the place of use of the machine!
- Relevant accident prevention regulations and other generally accepted safety and occupational medical rules are to be observed.
- The machine may only be used in technically faultless condition and according to regulations, with full knowledge of safety and risks, in accordance with these operating instructions! Faults impairing safety must be eliminated immediately!
- The operator is to wear personal protective equipment as prescribed by local regulations!
- For all works concerning operation, conversion, and settings of the machine and its safety systems, observe the entry and exit processes as well as emergency shut-down in accordance with operating instructions!
- When carrying out inspection, maintenance and repair on the machine, any safety measures within the frame of these activities must be observed!

2.2.5 Instructions for safe transport

- Wear protective helmet, safety footwear, and protective gloves during transport!
- Never stand under hanging loads!
- Only use suitable and tested lifting gear!
- Only use suitable, standardised and tested lifting gear (fork lift, automatic crane, hall bridge crane) and lifting tackles (round loops, lifting belts, lifting sling, and chains) for transport to the installation site.
- Always take maximum load bearing capacity into account when selecting lifting gear and lifting tackles!
- Please see Technical Data ([see chapt. 3 Technical data, page 16](#)) for dimensions and weight.
- Please always ensure that the machine is transported without shocks and blows.
- Observe the icons on the packaging.
- Notify the supplier of any transport damage and/or missing parts immediately.
- Always transport switch cabinets vertically!
- Only fasten transport boxes and frames to the labelled anchors!
- Always secure loads to be transported against falling or tipping over!
- All transport safeguards may only be removed after installation!

2.2.6 Safety during operation

- The machine may only be operated by trained persons.
- The machine may only be operated in assembled operable condition.
- The machine may only be operated once all safeguards ([see chapt. 2.4 Safety devices, page 12](#)) and safety-related systems, e.g. detachable safeguards, covers, are available and serviceable.
- Set-up operation may only be carried out by qualified personnel, because work on terminal switches and machine components may trigger undesirable movements that could lead to serious injuries.
- The machine is to be checked at least once per shift to detect any external visible damage and defects! Any occurred changes (including operating behaviour changes) are to be notified immediately to the responsible department/person! The machine is to be shut down and secured if necessary!
- The machine should never be left unattended during operation!
- Entry and exit processes, control lamps are to be observed in accordance with the operating instructions!
- When shutting down the machine, it should always be switched off by the operating personnel and secured against re-setting by unauthorised persons.
- The mains plug is to be pulled out prior to each relocation or for machine interventions!
- Do not operate the machine near flammable materials!
- Only operate the machine with according working clothes:
 - long-sleeved outer clothing
 - long pants

- protective gloves in suitable material
- Do not touch rotating parts during operation!
- Be aware that parts continue to rotate e.g. after operating the emergency OFF key or opening the protective hood!
- Do not touch the feed with your hands during operation and do not deposit or store objects in this area!
- Two emergency OFF push buttons ensure switch-off in case of emergency. They are located on the machine control panel as well as at the end of the last module.
- In case of jammed skis or boards, the emergency OFF key must first be actuated. Afterwards, the ski or board can be removed.

2.2.7 Safety instructions for maintenance, repair and fault elimination

- Regular check/inspection intervals prescribed or specified in the operating instructions are to be adhered to.
- All maintenance and repair works can only be carried out once the main switch is switched off. Manual interventions on a running machine can lead to serious accidents and are therefore prohibited. If it is necessary to switch on the machine during such activities, this may only be within permissible operating modes upon observing special safety measures.
- Safe and environmentally-friendly disposal of operating supplies and auxiliary materials as well as replacement parts is to be ensured.

2.2.8 Safety during work on electrical system

- In case of faults of the machine electrical equipment, the machine is to be switched off immediately with the main switch!
- Works on machine electrical system may only be performed by electrical engineers according to electrotechnical rules! Only electrical engineers may have access to the machine electrical equipment and perform works on it. Keep the switch cabinets closed at all times as soon as they are unattended.
- Never work on live parts! Machine parts requiring inspection, maintenance and repair works must be switched off. Operating supplies which were used for enabling the machine are to be secured against unintended or automatic reset (close fuses, block disconnect switch, etc.). The enabled electrical components must first be checked for deadness, then grounded and short-circuited, and adjacent live components must be insulated!
- Only original fuses with prescribed current strengths are to be used! Never repair or connect defective fuses. Replace fuses only with same-type fuses.
- Changes on the control programme can impair safe operation. Programme changes may only be carried out with the manufacturer's authorisation.
- Correct grounding of the electrical system must be ensured through a protective earth conductor system.

2.2.9 Safety during work on pneumatic system

- Works on pneumatic equipment may only be carried out by qualified skilled personnel with special knowledge and experience in this subject!
- All pipes, hoses, and pipe fittings are to be checked regularly for leakage and externally visible damage! Damaged parts are to be exchanged immediately!
- If system parts and delivery pipes need opening, they must be unpressurised before starting repair works!
- Keep your hands off the machine parts after switching on the compressor! The produced work pressure may lead to the pneumatic cylinder's basic position being displaced due to pressure inflow.

2.3 Warning signs



Risk of injury!

Regular checks must be made to ensure that the warning labels are still attached to the machine. Illegible or missing warning labels must be replaced immediately.



Wear gloves!

Order number: 78-150-678



Attention! Hot surface!

Order number: 78-150-121



Carefully read operator's manual before handling the machine and observe instructions and safety rules when operating!

Order number: 78-166-001

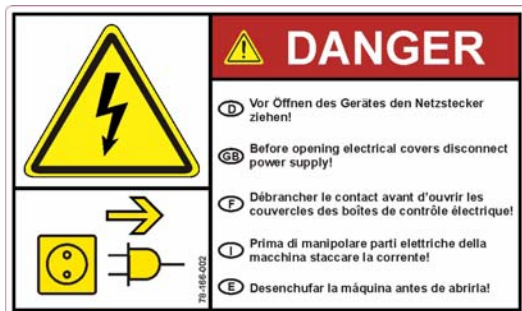

Before opening electrical covers disconnect power supply!

Order number: 78-166-002



Before changing the stone, check max. permitted rpm of new stone!

Order number: 78-166-005



Risk of stone getting out of balance! Never spray the stone when it is stationary!

Order number: 78-166-021



Keep hands out of magazine during operation!

Order number: 78-166-003



Keep hands out of feed during operation!

Order number: 78-166-009

Order number: 78-166-009

2.4 Safety devices

The following safety devices must not be removed during operation:

- [1] Sliding door front side
- [2] Rear cover
- [3] Front cover

as well as any other protections and covers that ensure safe and injury-free operation!

Opening of the sliding door (1):

- the main switch must be switched on
- press the stop button
- the sliding door can be opened after approx. 15 seconds or after report on the display.

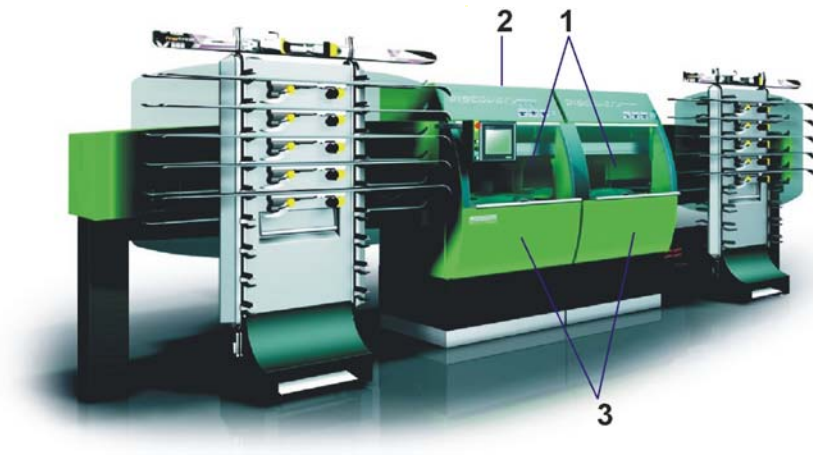

2.5 Purpose of use

The machine is designated only for the following processes on alpine skis, cross-country skis and snowboards:

- Belt pre-grinding for side edge and base
- Stone pre- and fine grinding
- Processing of side and base edge, grinding angle can be variable

in mm	SKI	SNOWBOARD	XC-SKI	WIDE SKI
max. width:	140	340	70	180 (Special mode)
min. width:	55	200 (with adapter 150)	40	110
max. length:	2100	2100	2100	2100
min. length:	920	1000	920	1000

! Wide skis with a maximum width of 135 - 180 must be ground in "EXTRA" mode without the ski magazine (see [chapt. 9.2.3 Grinding a ski with a width of between 135 and 180 mm., page 37](#))! The minimum width must be no less than 110 mm.

Rocker and V-Shape skis can be ground with the ski magazine in "EXTRA" mode (see [chapt. 9.2.4 Grinding a Rocker or V-Shape ski, page 39](#)).

XC skis must be ground in "EXTRA" mode without the ski magazine (see [chapt. 9.2.2 Grinding a cross-country ski, page 36](#)).



Twin tip



Rockered

! In the event that any of the above instructions is not adhered to, WINTERSTEIGER company will refuse any liability for any damage caused!

2.6 Function

- Menu control via Touch Screen Display
- Automatic charging and discharging for max. 16 skis, or manual charging for one snowboard
- Two separate feed modules for optimum throughput
- Ski stoppers are clamped up by an elastic band or dummy sole

Module PREGRIND [P] (option)

- Belt grinding for very smooth and fibre-free base
- Belt oscillation for extended belt life
- Wave-free and extremely fine wet grinding of side edge with oscillating ceramic inserts and grinding belt

Module STONE [S]

- Stone grinding with more cycles (the ski is moving back-and-forth - processing both directions)
- Wide application of grinding pressure from below - pneumatic for uniform grinding
- Stone oscillation for extended stone life
- Side edge processing and base edge processing

3 Technical data

Type	Discovery PS
Nominal voltage; frequency; capacity; nominal current; fuse protection min./max.:	3N AC x 380-415 V; 50/60 Hz; 15.4 kW; 28.7 A; 32/32 A
Allowed ambient temperature:	+ 10 to 30 °C
Dimensions:	see following graphic
Operating pressure:	7 bar
Air consumption:	200 l/min Use only dry and oil-free air!
Total weight:	approx. 3325 kg
Volume water tank:	450 litres
Max. grinding stone diameter:	300 mm
Min. grinding stone diameter:	210 mm
Diameter of ceramic discs:	154 mm
Diameter of ceramic discs for kids ski (option):	150 mm
Effective depth of ceramic discs:	ca. 25 mm
Noise emission:	In an average grinding process the continuous pressure sound level is approx. 83 dB(A) at a distance of 1 meter (3 ft).

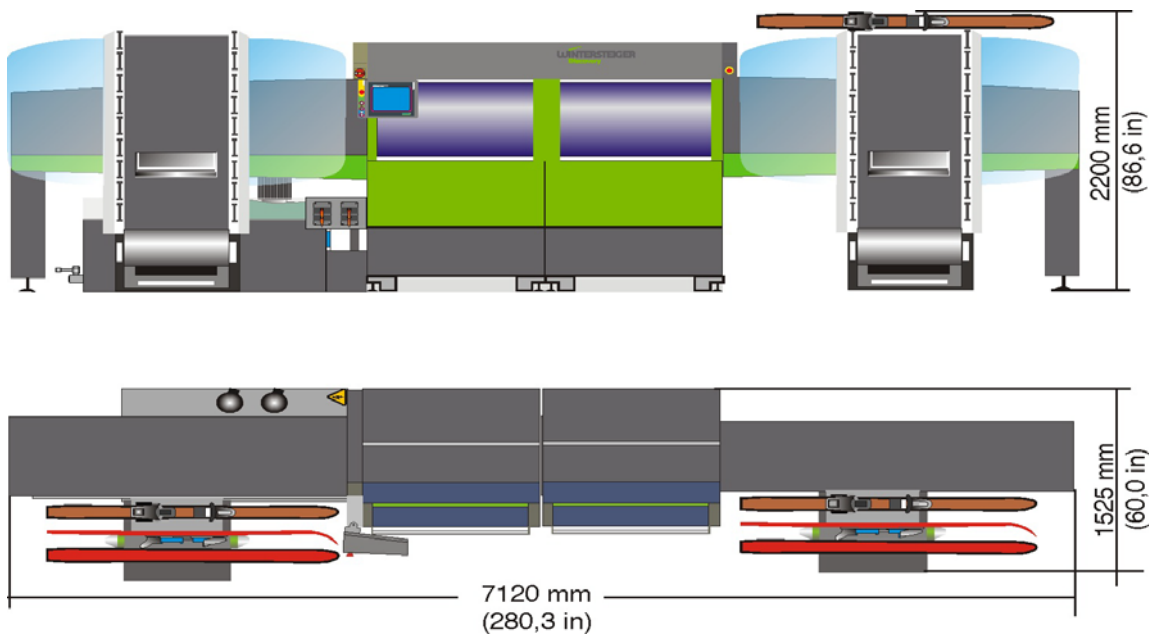

4 Transport and setup

- The floor must be suitable for min. area load of 15000 N/m²
- See following graphic for transport by highlift truck
- By removing the operating panel, opening the sliding doors and demounting the sliding-door frame the machine has a transport width of 880 mm (see following graphic).
- Align the machine horizontally and vertically with a water level by means of the adjusting feet [A]!
- Setup and installation of the Discovery must be carried out by an WINTERSTEIGER technician!
- Workplaces see illustration

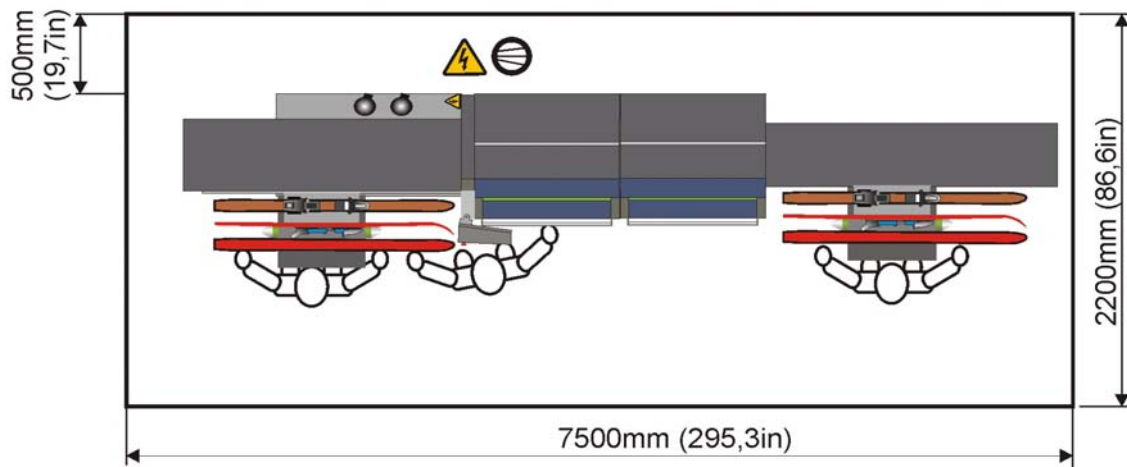
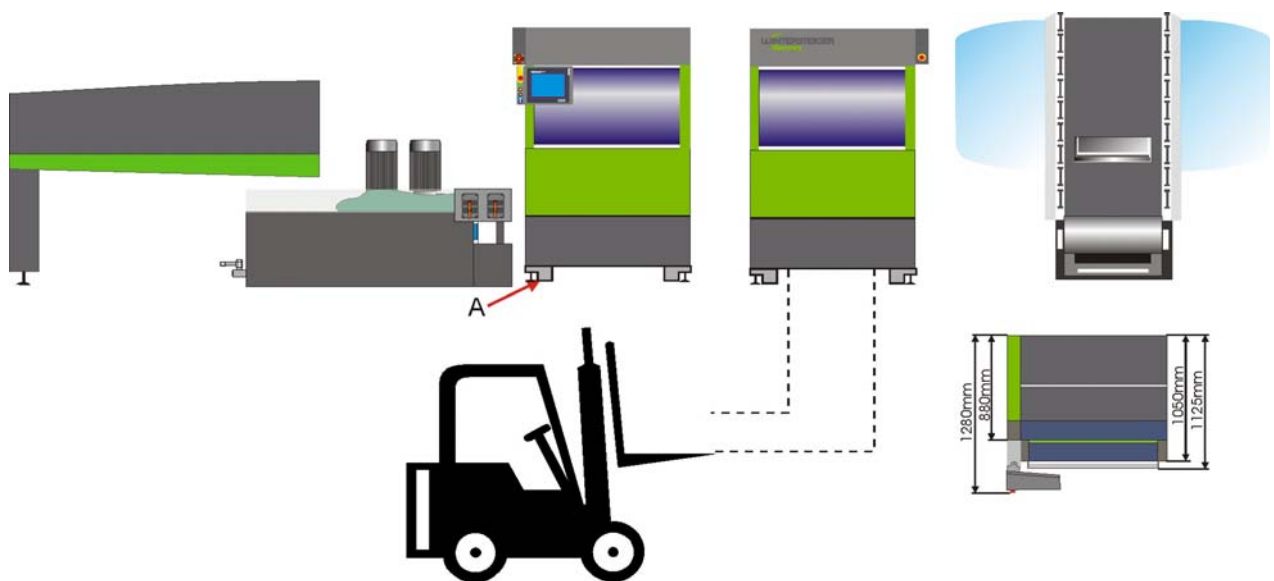

5 Connections and other preparations

- Remove the safety device of transport
- Connect compressed air
- Adjust air compressor to 7 bar (101 psi)
- Installation only by skilled electricians
- Observe the correct voltage. The machine voltage is shown on the data plate!
- Note the correct rotating direction of the motors. See red arrows on the grinding units. Correction of rotating direction should only be made by skilled electricians!
- A supply of water near the machine will facilitate changing the coolant and the refilling.



It is pointed out that the use of residual current devices are not recommended, as the rotational speed controller uses a frequency converter with supply filter. In the case of a malfunction the sensitivity of the residual current circuit-breaker will be reduced due to the existing position of direct current. Protection measures have to comply with local regulations and codes of practice.

If, however, because of safety-technical reasons the use of residual current devices is mandatory, they should be suitable for direct, alternating, high frequency and earth current applications (e.g: ABB model series F804, or equivalent devices).

5.1 Preparation for operation



For your safety!

Check whether all safeguards and covers are mounted!

5.1.1 Pneumatic system

- Operating pressure must be 7 bar at system pressure manometer [A], otherwise do not use the machine!
- The pressure regulator [B] is used for the pressurization of the motors and must not be adjusted!

5.1.1.1 Cut off compressed air

- Cut off compressed air by the stop valve [E].



Turn off the air pressure at night!

Air pressure has to be switched on and show a pressure of 7 bar before switching on the machine!

5.1.2 Coolant tank

- Use only water-emulsion mixture!
- Machine must not be cleaned or operated with water alone!
- Do not clean the machine with the help of a high-pressure cleaner! In the event that this instruction is not adhered to, WINTERSTEIGER will refuse any liability and guarantee for any damage caused.
 - Observe level of coolant according to mark at the level indicator [C].
 - Attach filter bag to outlet [D].

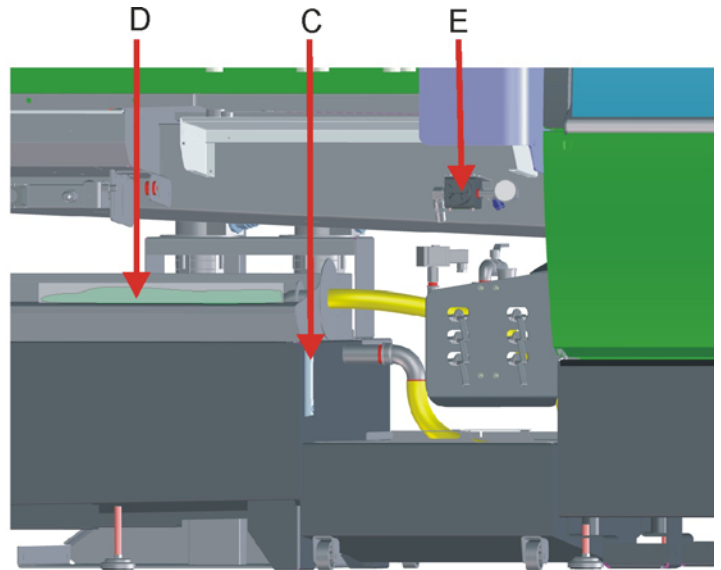
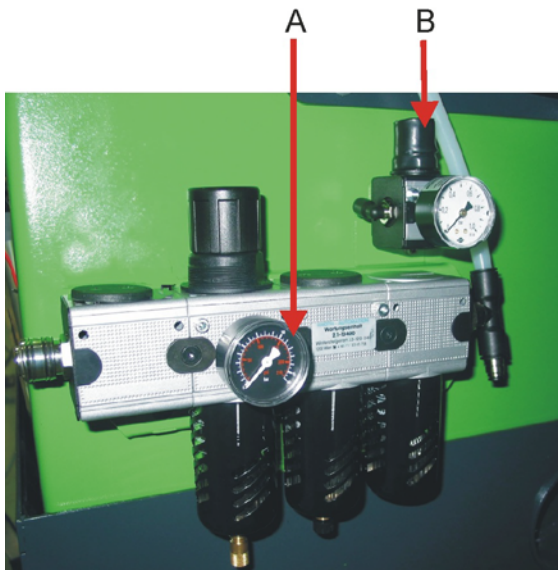

6 Description of the operating elements

6.1 Operating elements operating panel

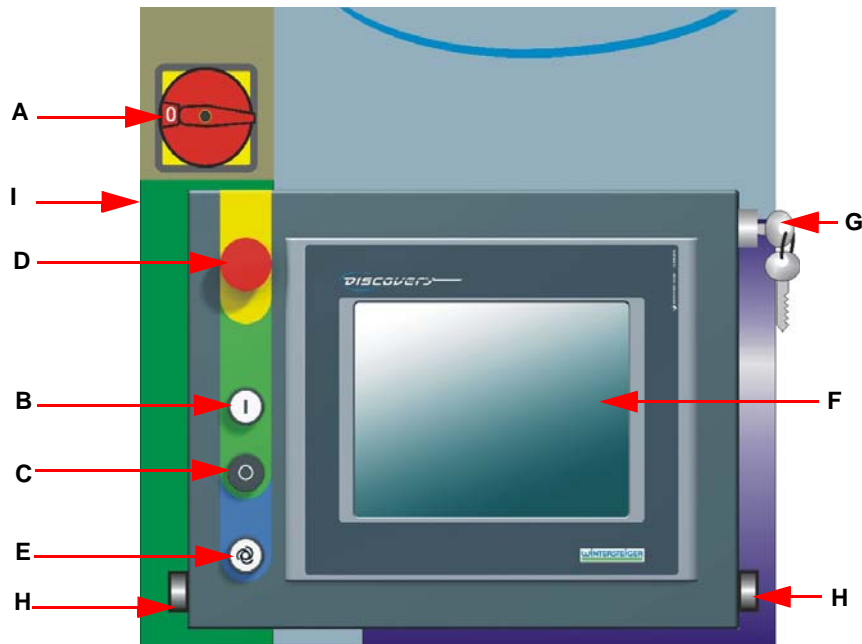

A: Main switch:

Used for switching on and off the complete power supply. The main switch is situated above the operating panel.

B: Start button:

- Used for switching on the machine. The display will show the start image when the power supply is working properly.

C: Stop button:

- When no ski is being processed, the machine switches off when the stop button is pressed
- When still working, the machine finishes operation and discharges the ski (board) quickly after pressing of stop button

D: Emergency stop button:

- Shuts off machine in case of danger.



This key remains down and switching the machine on with [B] key again will not be possible! Pulling out the key will unlock it, allowing key to return to its initial position - machine can now be switched on with [B] key again.

E: Start working process

- By actuating the switch [E] processing starts and the displayed program will be activated automatically. The charging just starts when the machine is ready for operation.

F: Touch-Screen monitor

- Touch-Screen function of the display guarantees optimum control of the machine. A light touch activates the respective field.



Do not touch the screen with sharp objects like biro, knife etc. A special pen can be ordered at WINTERSTEIGER (Art. no. 7000-0811-V01).

G: Key switch manual charging



Manual charging is for grinding snowboards and cross country skis. It can also be used for skis in case of a breakdown of the ski magazine.

- The ski magazines can be removed when turning the key switch to manual charging.

H: Start working process without ski magazines



Risk of injury!

The charging starts automatically. Therefore be careful when working in the charging area. Keep hands away during charging process!

- Working process with manual charging can be started by actuating the two keys [H] simultaneously.

I: USB-port

- USB-port for any program updates

6.2 Operating elements ski magazine

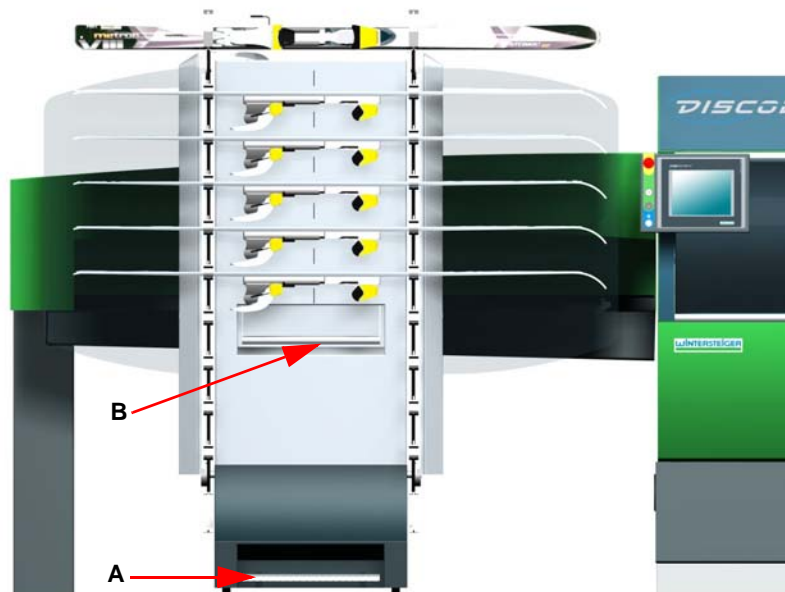

A: Pedal ski transport

- By a short actuation of the pedal [A] the magazine moves to the next position. By a continuous actuating of the pedal the magazine moves until the first ski reaches the conveyor belt or the pedal is released.

B: Unlocking the ski magazine

- Push up the bow [B] and remove the ski magazine by pulling.



WARNING

Risk of injury!

If the ski magazine is removed during working process and if the key switch was not turned to manual charging, the emergency stop is activated!

6.3 Operating elements module PREGRIND

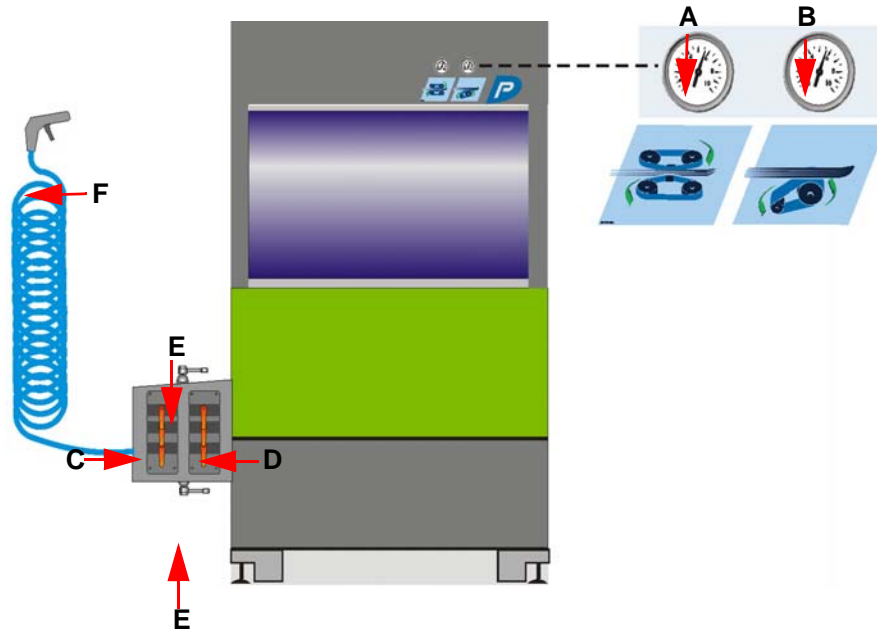

A: Grinding force gauge SEG

- The grinding force of the SEG is shown on manometer [A].



Adjustment of the grinding force SEG [see chapt. 10.4.1 Parameters SEG, page 48.](#)

B: Grinding force belt unit

- The grinding force of the belt unit is shown on manometer [B].

C: Ball valve coolant supply - SEG

- This handle [C] regulates amount of coolant supplied to spraying nozzles of SEG.

D: Ball valve coolant supply - belt unit

- This handle [D] regulates amount of coolant supplied to the belt unit.

E: Central stop valves cleaning

- These two handles close all ball valves to allow cleaning of the machine with the cleaning hose.

F: Cleaning hose for cleaning of the machine

6.3.1 Adjustment of the grinding angle SEG

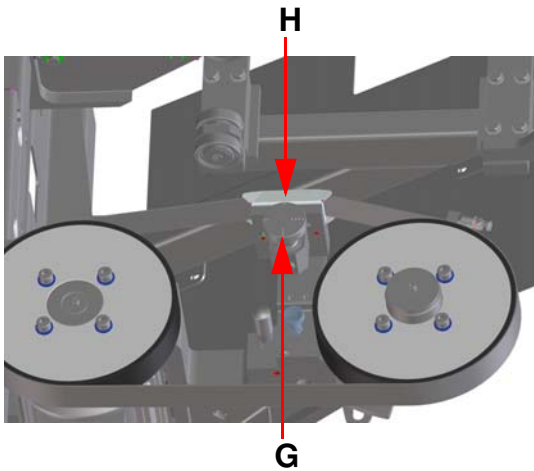

- Adjust by twisting the marked hand wheel [G] to grinding block [H]..

Position	Angle side edge	Effective edge angle (combined with disc grinding)
I	89°	90°
II	88°	89°
III	87.25°	88°
IIII	86.25°	87°



Adjust left and right side equally! The adjusted grinding angle has to be adopted to the disc unit!

6.4 Operating elements module STONE

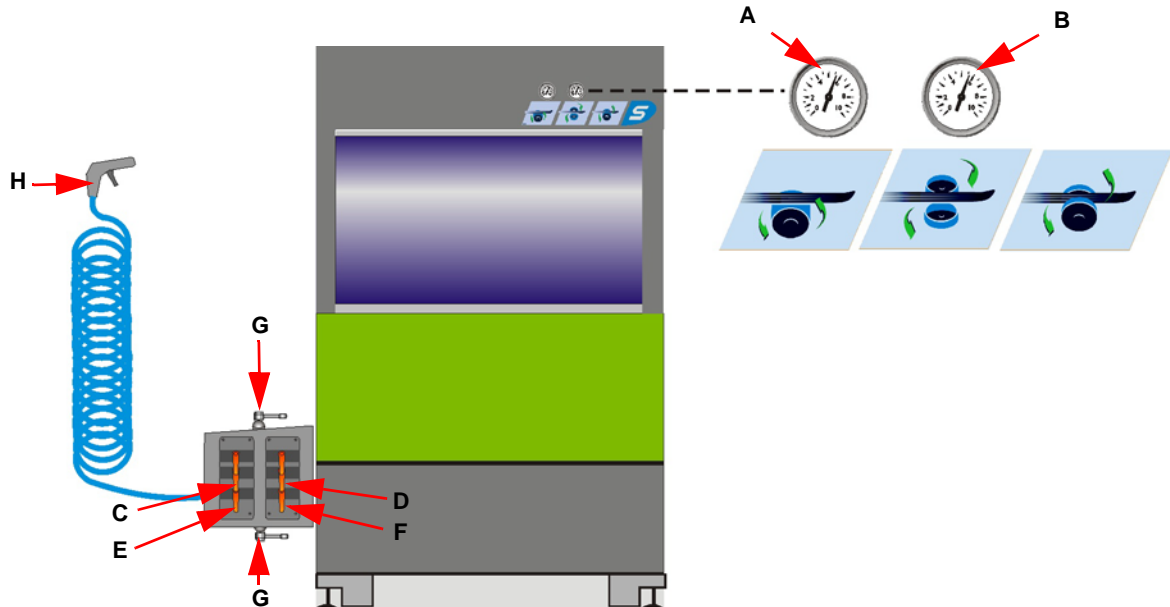

- A: Grinding force stone grinding
- The grinding force of the grinding stone is shown on manometer [A].
- B: Grinding force disc grinding
- The grinding force of the SE and BE processing is shown on manometer [B].



Adjustment of grinding force for stone and disc grinding (see [chapt. 10.5 Stone unit - change parameters, page 55](#) and [chapt. 10.6 Disc unit - change parameters, page 70](#)).

Module 1:

- C: Ball valve coolant supply - high pressure nozzle stone
- This handle regulates amount of coolant supplied to the high pressure nozzle of stone unit. Spraying unit for grinding stone should be completely open if possible.
- D: Ball valve coolant supply - disc unit
- This handle regulates amount of coolant supplied to the spraying nozzle of disc unit.

Module 2 (option):

- E: Ball valve coolant supply - high pressure nozzle stone [module2]
- This handle regulates amount of coolant supplied to the high pressure nozzle of stone unit. Spraying unit for grinding stone should be completely open if possible.
- F: Ball valve coolant supply - disc unit [module2]
- This handle regulates amount of coolant supplied to the spraying nozzle of disc unit.

Modul 3 (option):

- Two additional ball valves regulate amount of coolant supplied to the high pressure nozzle of stone unit and disc unit.

G: Central stop valves cleaning

- These two handles close all ball valves to allow cleaning of the machine with the cleaning hose.

H: Cleaning hose for cleaning of the machine

6.4.1 Adjustment of the grinding angle disc

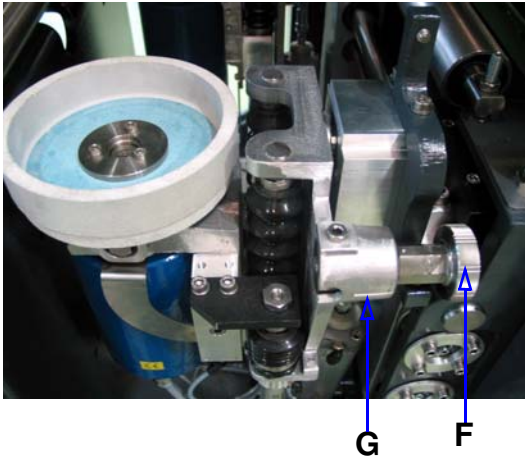

- Adjust by twisting the marked hand wheel [F] to notch [G].

Combined grinding angles for SE and BE: tolerance +/- 0.25°

Position	Angle BE	Angle SE	effective edge angle
1	1°	89°	90°
2	1°	88°	89°
3	0.75°	87.25°	88°
4	0.75°	86.25°	87°
5	2°	88°	90°
6	3°	88°	91°
7	4°	87°	91°



Adjust left and right side equally! The adjusted grinding angle has to be adopted to the module PREGRIND if available.

7 Charging of the ski magazine

- Switch on main switch and press start key of the operating panel.

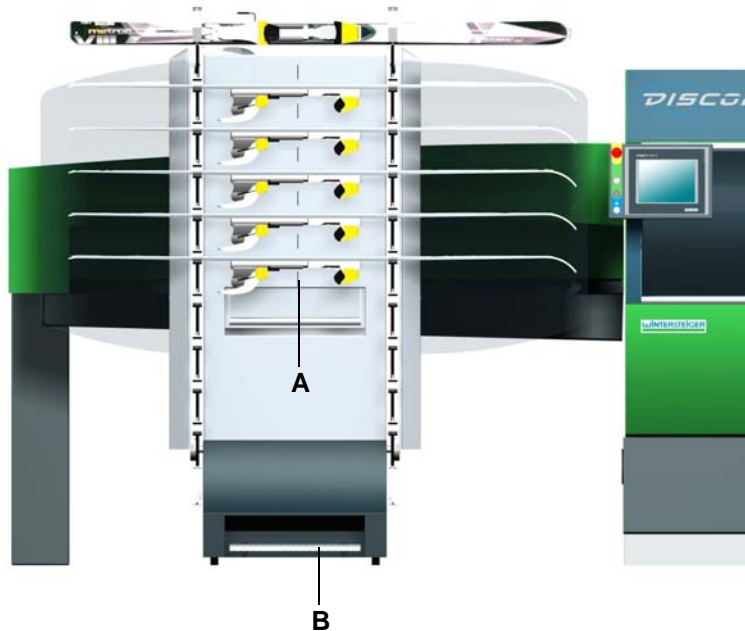

Ski stoppers have to be clamped up with an elastic band.

Take care that ski stoppers, which stick out compared to the ski, are 15 mm above base edge of the ski! Put the ski upside down into the ski magazine. The middle of the ski binding has to be at marking [A]. Ski tip must be on right side.

- By a short actuation of the pedal [B] the magazine moves to the next position. By a continuous actuating of the pedal the magazine moves until the first ski reaches the conveyor belt or the pedal is released.



CAUTION Risk of injury!

The ski magazine starts automatically. Therefore be careful when working in the charging area.

Keep hands away during operation of ski magazine! Do not place or lean any objects on the ski magazine!

If a ski gets stuck in the machine during processing:



- press emergency stop button [D]
- after 50 seconds the doors can be opened
- remove ski or board
- switch machine on again



When actuating the emergency stop button the ski/board may be damaged!

8 Load - save - delete grinding program

- Switch on main switch.
- Press start key.
After a short initialization the main screen is shown



8.1 Load grinding program



By actuating the key "Programs" the list with all preset WINTERSTEIGER grinding programs is opened.

This list contains three different categories:

- SKI
- BOARD
- EXTRA (e.g.: cross-country ski)
- Therefore select the respective category according to ski or board which has to be ground by actuating the respective register.

Each category includes two preset programs.

Select desired program by touching the respective line, then press key "OPEN".

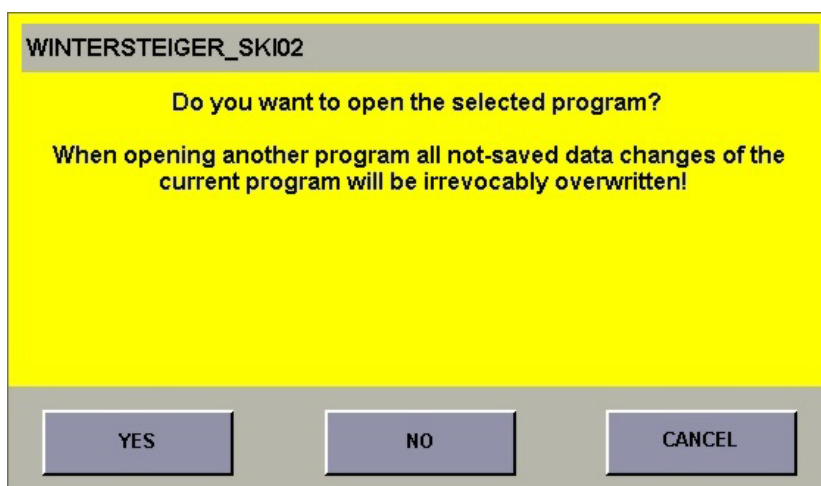

- The changes made in the previous program can be adopted. Therefore the screen in the margin appears.
- By actuating the key "YES" the new selected program will be opened without saving the changes of the previous program.
- By actuating the key "NO" or "CANCEL" you go back to the program list to save the changed program, if necessary.

8.2 Save grinding program

By actuating the key "Programs" in the main screen you open the list with the grinding programs.

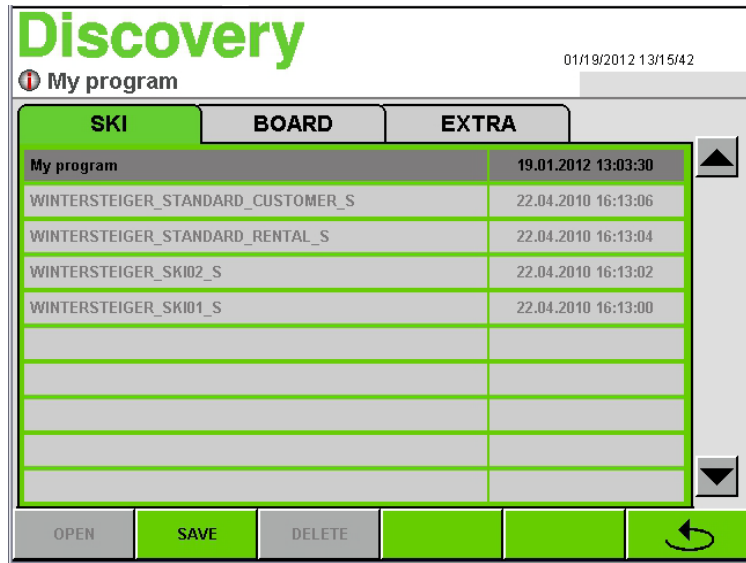

The current program is shown inversely.

i The preset WINTERSTEIGER programs are write-protected (shown light grey). They can be changed but have to be saved with another name then (Save as).

By actuating the key "SAVE" the following screen appears.

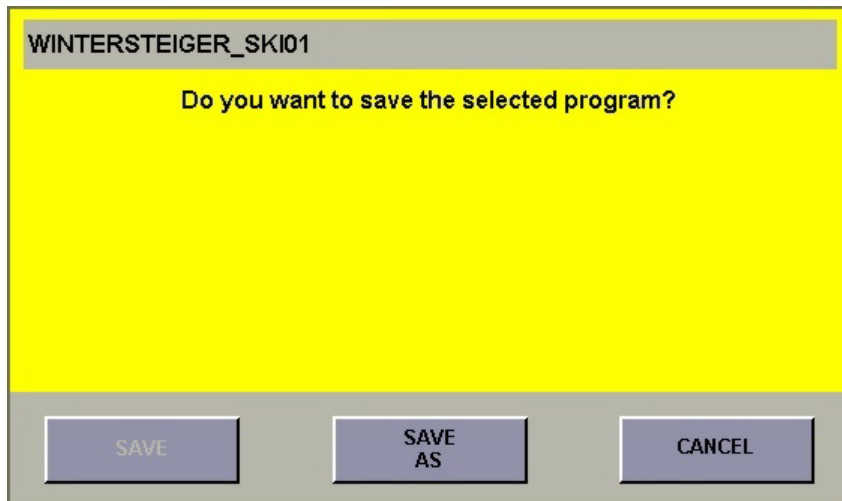

By actuating the key "SAVE" again, all changed parameters and adjustments are adopted. Then you go back to the main screen automatically.

i This example is shown with a write-protected program, so the key "SAVE" is shown inversely and can not be activated.

8.2.1 Save as



If you want to save the selected or changed program with a new name, press the key "SAVE AS".

- An alphanumeric input field is opened.
- Create the desired name by actuating the respective letters.
- By actuating the key "↑" you change between capitals and small letters.
- By pressing the key "ESC" you cancel this operation.
- By pressing the key "ENTER" you confirm input.

8.3 Delete grinding program

- By actuating the key "Programs" in the main screen you open the list with the grinding programs.



The current program is shown inversely.

i The preset WINTERSTEIGER programs are write-protected and can not be deleted. Also the current program can not be deleted.

- Select the program you want to delete and confirm with key "DELETE".

8.4 Program info

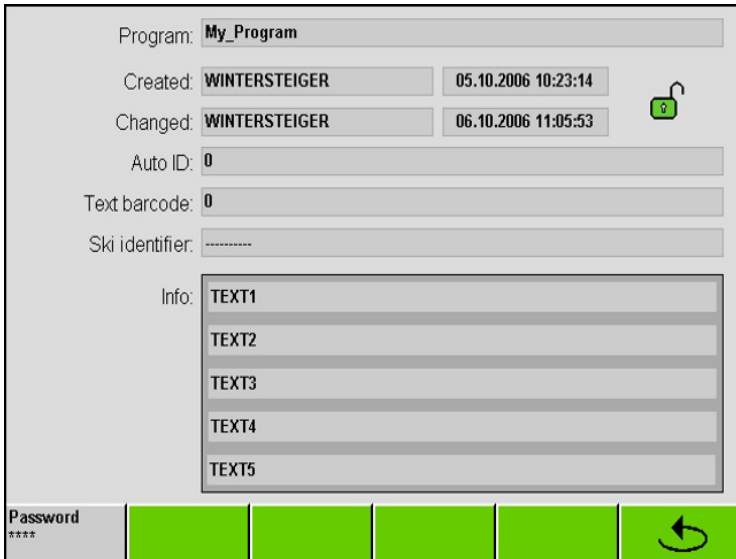

- The "Program info" window is opened by pressing the program name on the main screen.
- Program information can be saved in this window by actuating the Info text lines using the input field.
- The program info window can be write-protected - or the protection can be cancelled - by entering the password "4900" in the Password window and pressing the lock icon.

9 Working with the machine

- Switch on main switch.
- Press the start button.

The main screen appears after a short initialization.

9.1 Handling when working with the ski magazine

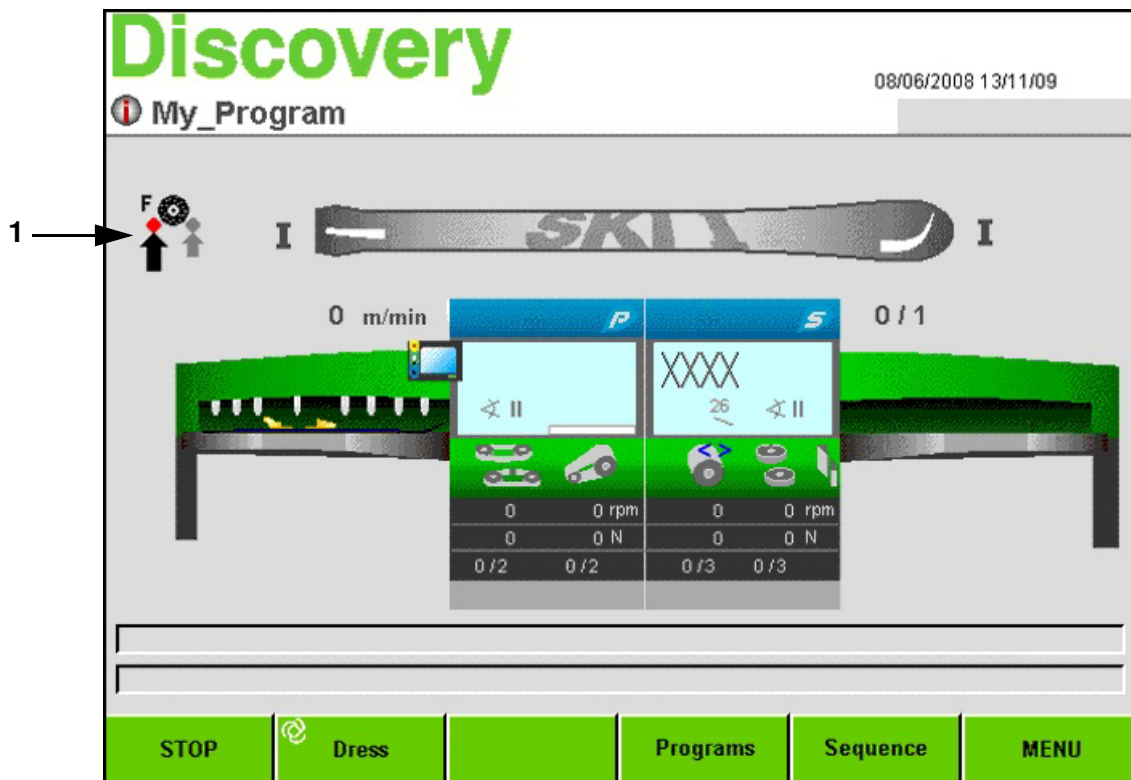

- 1) Charge the ski magazine



Ski stoppers have to be clamped up with an elastic band.

Take care that ski stoppers, which stick out compared to the ski, are 15 mm above base edge of the ski!
Put the ski upside down into the ski magazine. The middle of the ski binding has to be at marking [A]. Ski tip must be on right side.

- 2) Check if the discharging magazine is ready for charging skis.

- 3) Open desired program, adjust grinding angles for edge grinding processes if necessary.

! **Reduce grinding force [1]**
When grinding children skis, it is imperative to reduce the grinding force through the selection of the small arrow [1].

CAUTION Risk of injury!

The ski magazine starts automatically. Therefore be careful when working in the charging area. Keep hands away during operation of ski magazine! Do not place or lean any objects on the ski magazine!

- 4) Then press button "Start working process".

CAUTION Risk of injury!

- 5) If a malfunction should occur in the charging or discharging area that is caused by a jammed ski or board, the emergency stop key must be pressed before intervening.

9.2 Handling when working without ski magazine

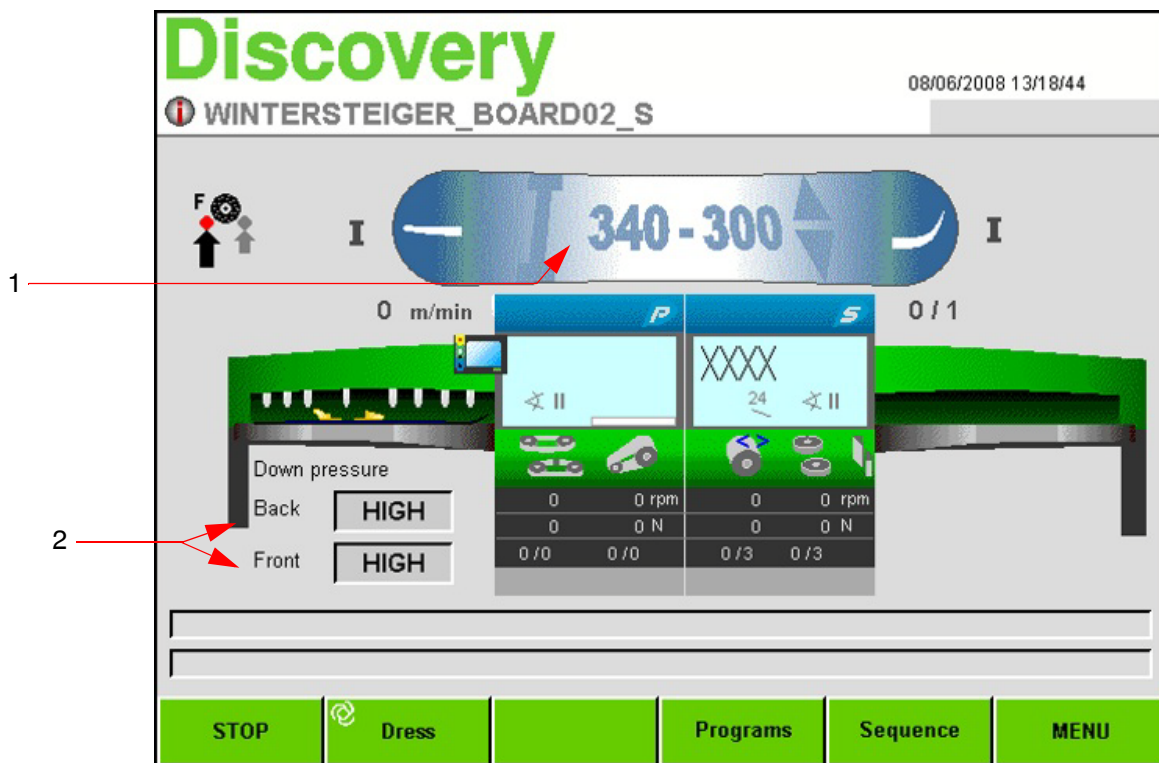

i Snowboards, skis with a width of between 135 and 180 mm or cross-country skis can only be ground with manual charging (without ski magazine). Manual charging can also be used for skis in case of a breakdown of the ski magazine.

9.2.1 Grinding a snowboard



- 1) Select the desired board program ([see chapt. 8.1 Load grinding program, page 28](#))
- 2) The angle adjustment of the edge grinding unit(s) may need to be corrected.
- 3) Turn key switch [A] to position manual charging
- 4) Remove ski magazines ([see chapt. 6.2 Operating elements ski magazine, page 21](#))
- 5) Put snowboard parallel on the front end of the charging platform up to transport stops [C].

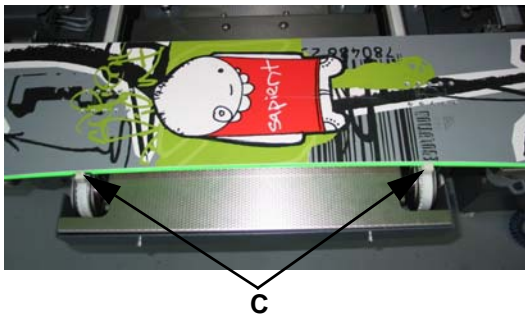

! Remove all loose parts (safety band, ...) before grinding the board.
 We recommend to demount the binding, so the binding must not be cleaned after the grinding process. If you grind without demounting the binding, take care that the binding is positioned between the down-holders.

- 6) Press both buttons [B].

The message window which appears will ask you to check the board width:

Was the correct board width selected on the main screen [1]?

- Board I 340...300 mm
- Board II 300...270 mm
- Board III 270...240 mm
- Board IV 240...210 mm

- 7) Once these items have been checked, the message window must be closed by pressing the OK button
- 8) By keeping the two buttons [B] pressed the board is moved into the machine, centered and the grinding cycle is started.

i If the buttons are released early, the transport is interrupted. Charging will be continued by pressing the buttons again.

CAUTION Risk of injury!

Take care that there is no one near the charging and discharging areas.

When grinding snowboards, the holding-down pressure can be set different for the front and the back.

- A reduced pressure (LOW) can be assigned to the front or rear holding-down device by pressing the respective buttons [2].

i This application is a special advantage with convex Boards.

9) The board is transported to the discharging area after the grinding process.



Do not take off the board before it was completely discharged!

10) The next board can be charged when feeder has taken it's initial position in the charging.



If a malfunction should occur in the charging or discharging area that is caused by a jammed ski or board, the emergency stop key must be pressed before intervening.

9.2.2 Grinding a cross-country ski

! Prior to grinding cross-country skis, the centering adaptors (optional, order No. 8550-1111-V03) must be mounted on the centering devices of the charging unit.

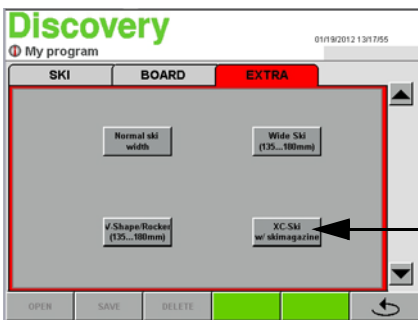

- 1) Select the "EXTRA" tab.
- 2) Select "XC ski w/ skimagazine" [1].

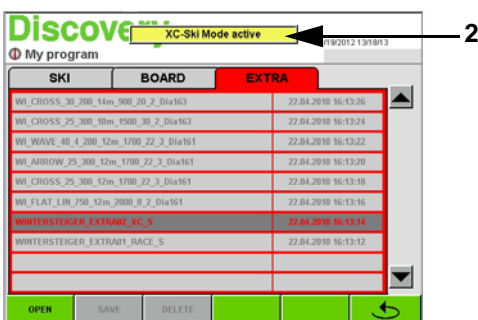

- 3) Select the desired program ([see chapt. 8.1 Load grinding program, page 28](#))

i This operating mode will be displayed in the upper screen section [2] for as long as the mode is enabled!



- 4) Turn key switch [A] to position manual charging
- 5) Remove ski magazines ([see chapt. 6.2 Operating elements ski magazine, page 21](#))
- 6) Position the cross-country ski on the front end of the charging unit and align with the two transport stops.

! If you grind without demounting the binding, take care that the binding is positioned between the down-holders.

7) Press both buttons [B].

The message window which appears will ask you to check the following items:

- Please check whether the centering adaptors are installed.
- Please note the selected processes! Is edge working selected?
- Please check the selected grinding force! It may be necessary to reduce the grinding force by selecting the small arrow on the main screen.

8) Once these items have been checked, the message window must be closed by pressing the OK button.

9) By keeping the two buttons [B] pressed the ski is moved into the machine, centered and the grinding cycle is started.



If the buttons are released early, the transport is interrupted. Charging will be continued by pressing the buttons again.

For safety reasons grinding only takes place with the front feeder!



CAUTION Risk of injury!

Take care that there is no one near the charging and discharging areas.

10) The ski is transported to the discharging area after the grinding process.



CAUTION Risk of injury!

Do not take off the ski before it was completely discharged!

11) The next ski can be charged when feeder has taken it's initial position in the charging.



CAUTION Risk of injury!

If a malfunction should occur in the charging or discharging area that is caused by a jammed ski or board, the emergency stop key must be pressed before intervening.

9.2.3 Grinding a ski with a width of between 135 and 180 mm.

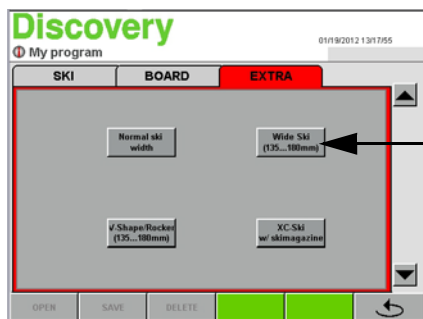

1) Select the "EXTRA" tab.

2) Select "Wide ski (135 ... 180mm)" [1].

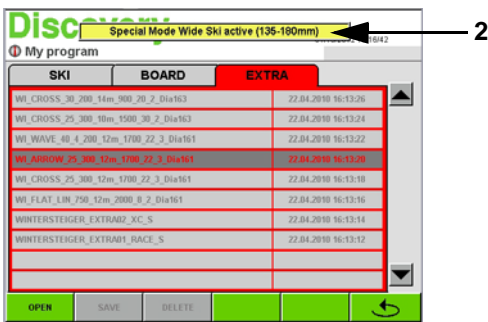

- 3) Select the desired program ([see chapt. 8.1 Load grinding program, page 28](#))



This operating mode will be displayed in the upper screen section [2] for as long as the mode is enabled!



- 4) Turn key switch [A] to position manual charging
 5) Remove ski magazines ([see chapt. 6.2 Operating elements ski magazine, page 21](#))
 6) Position the wide ski on the front end of the charging unit and align with the two transport stops.



If you grind without demounting the binding, take care that the binding is positioned between the down-holders.

- 7) Press both buttons [B].

The message window which appears will ask you to check the following items:

- The widest ski tip must point to the right.
 - The ski must have a width of 135-180 mm!
 - The width at the narrowest point must be 110 mm!
- 8) Once these items have been checked, the message window must be closed by pressing the OK button
 9) By keeping the two buttons [B] pressed the ski is moved into the machine, centered and the grinding cycle is started.



If the buttons are released early, the transport is interrupted. Charging will be continued by pressing the buttons again.

For safety reasons grinding only takes place with the front feeder! To determine the ski type of the wide ski, the ski is measured prior to grinding.



Risk of injury!

Take care that there is no one near the charging and discharging areas.

- 10) The ski is transported to the discharging area after the grinding process.



Risk of injury!

Do not take off the ski before it was completely discharged!

11) The next ski can be charged when feeder has taken it's initial position in the charging.



Risk of injury!

If a malfunction should occur in the charging or discharging area that is caused by a jammed ski or board, the emergency stop key must be pressed before intervening.

9.2.4 Grinding a Rocker or V-Shape ski



In "V-Shape Rocker" mode you can grind skis up to a maximum width of 165 mm.

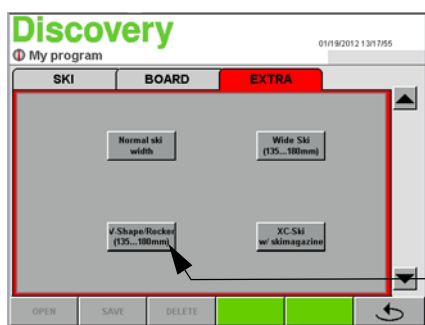

- 1) Select the "EXTRA" tab.
- 2) Select "V-Shape Rocker" [1].



- 3) Select the required program ([see chapt. 8.1 Load grinding program, page 28](#)).



This operating mode is displayed in the upper screen section [2] while the mode is enabled!

4) Charge the ski magazine



Ski stoppers have to be clamped up with an elastic band. Take care that ski stoppers, which stick out compared to the ski, are 15 mm above base edge of the ski! Put the ski upside down into the ski magazine. The middle of the ski binding has to be at marking [A]. Ski tip must be on right side.

5) Check if the discharging magazine is ready for charging skis.

- 6) Open desired program, adjust grinding angles for edge grinding processes if necessary.



Reduce grinding force [1]

When grinding children skis, it is imperative to reduce the grinding force through the selection of the small arrow [1].



Risk of injury!

The ski magazine starts automatically. Therefore be careful when working in the charging area. Keep hands away during operation of ski magazine! Do not place or lean any objects on the ski magazine!

- 7) Then press button "Start working process".



Risk of injury!

- 8) If a malfunction should occur in the charging or discharging area that is caused by a jammed ski or board, the emergency stop key must be pressed before intervening.

10 Change grinding program

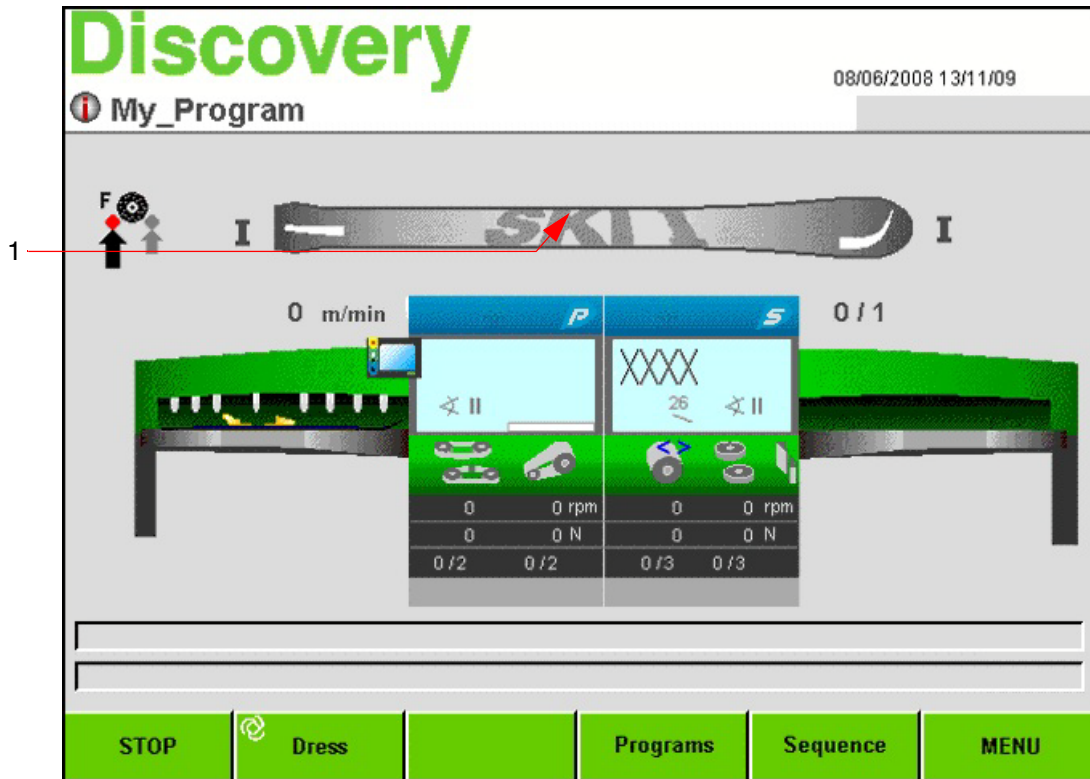

10.1 Automatic ski recognition

- The Discovery detects length, width and shape of ski and snowboards automatically. This is symbolically shown with the graphic [1].



When working without automatic ski recognition the ski or board type has to be selected manually by actuating the graphic [1].

SKI	Board	EXTRA (Ski)
SKI 1 = All-round Ski	Board 1 = 340mm - 300mm width	Extra 1 = RACE
SKI 2 = Carving Ski	Board 2 = 300mm - 270mm width	Extra 2 = XC
SKI 3 = Extreme Carving Ski	Board 3 = 270mm - 240mm width	Extra 3 = customized
	Board 4 = 240mm - 210mm width	



Take care of board width! The snowboard width is to be selected manually. Wrong selection can cause damages on the board or machine!

10.2 Tips for input fields



If the input field is actuated, a number block appears on the display, where you can enter the desired number. The value can be increased or decreased by pressing the arrow keys. Each input has to be confirmed with ENTER.

The screen can be left by pressing the key "" without changing the values. On the left top corner of the display the minimum and maximum input value is displayed.

10.3 Adjustment sequence of operations



Sequence of operations can be adjusted separately for each program.

- Load the program that should be changed
- Press key "Sequence" in the main screen
- The screen for sequence of operations is opened.

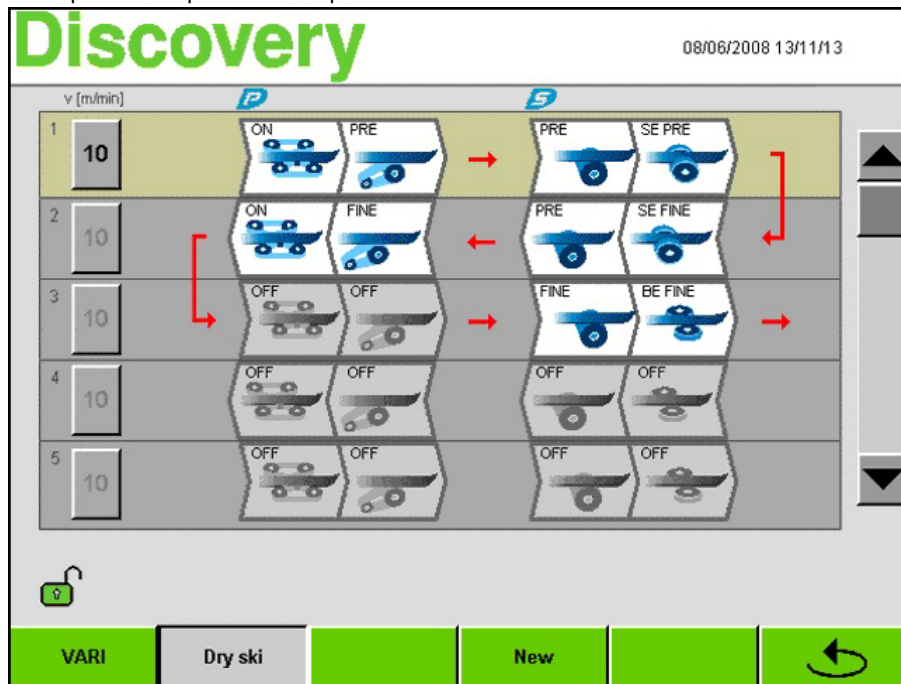

- Each processing step is shown symbolically. The processing direction of the ski/board is shown with the arrows.

Processing step according to example (screen above):

- 1) Side edge grinding belt (Module PREGRIND) [→]
- 2) Base grinding belt (Module PREGRIND) [↔]
- 3) Stone pre-grinding (Module STONE) [↔]
- 4) SE pre-grinding disc -(Module STONE) [→]
- 5) SE fine-grinding disc (Module STONE) [←] ski is processed in reverse direction
- 6) Stone pre-grinding (Module STONE) [←]
- 7) Stone fine-grinding (Module STONE) [→] ski is processed forward
- 8) BE fine-grinding Disc (Module STONE) [→]
- 9) Ski drying (Module STONE) [↔]

10.3.1 Selection of the processes

Following processes can be selected by actuating the symbols:

Module PREGRIND [P]

- Side edge grinding belt (marked with ON or OFF)
- Base processing belt (marked with ON or OFF)

Module STONE [S]

- Stone pre-grinding (marked with PRE)
- Stone fine-grinding (marked with FINE)
- Stone unit deactivated (marked with OFF)
- Disc SE pre-grinding (marked with SE PRE)
- Disc SE fine-grinding (marked with SE FINE)
- Disc BE pre-grinding (marked with BE PRE)
- Disc BE fine-grinding (marked with BE FINE)
- Disc unit deactivated (marked with OFF)

Ski drying

- The ski/board is dried after edge processing by actuating the key "Dry ski".



Thirteen stone processes and SE/BE processes can be selected.

10.3.2 Adjust feed speed

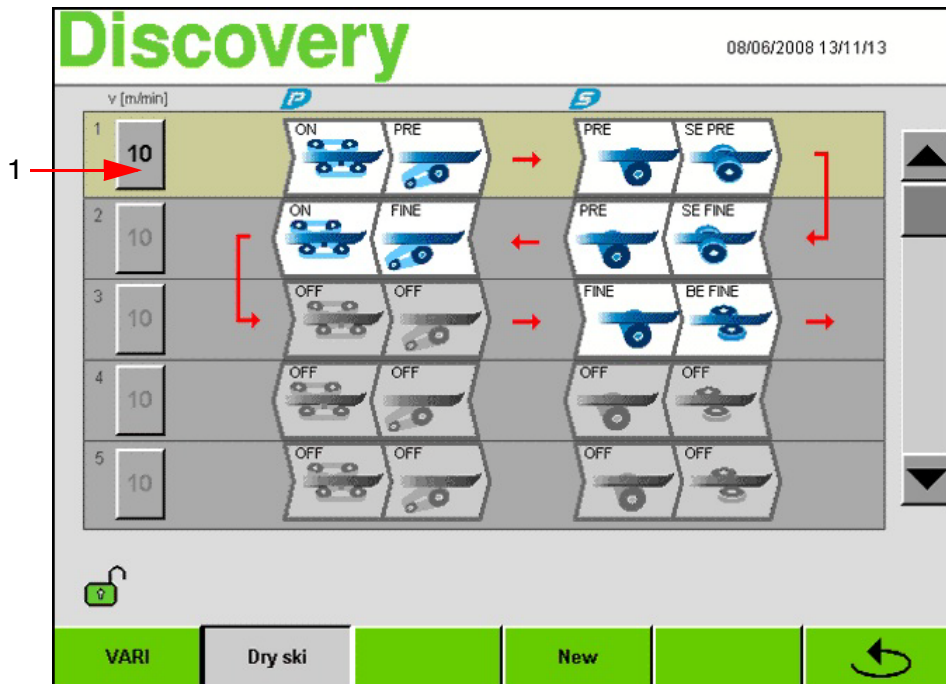

- By actuating the input field [1] the desired feed speed can be entered via the number block.
- Input area: between 3 and 15 m/min.

10.3.2.1 Variable feed speed

- By actuating the key „VARI“ different feed speeds can be used for the separate lines.

10.3.2.2 Delete the sequence of operations

- By actuating the key „New“ the whole sequence of operations is deleted.

10.3.2.3 Variable holding-down pressures with the snowboard programs

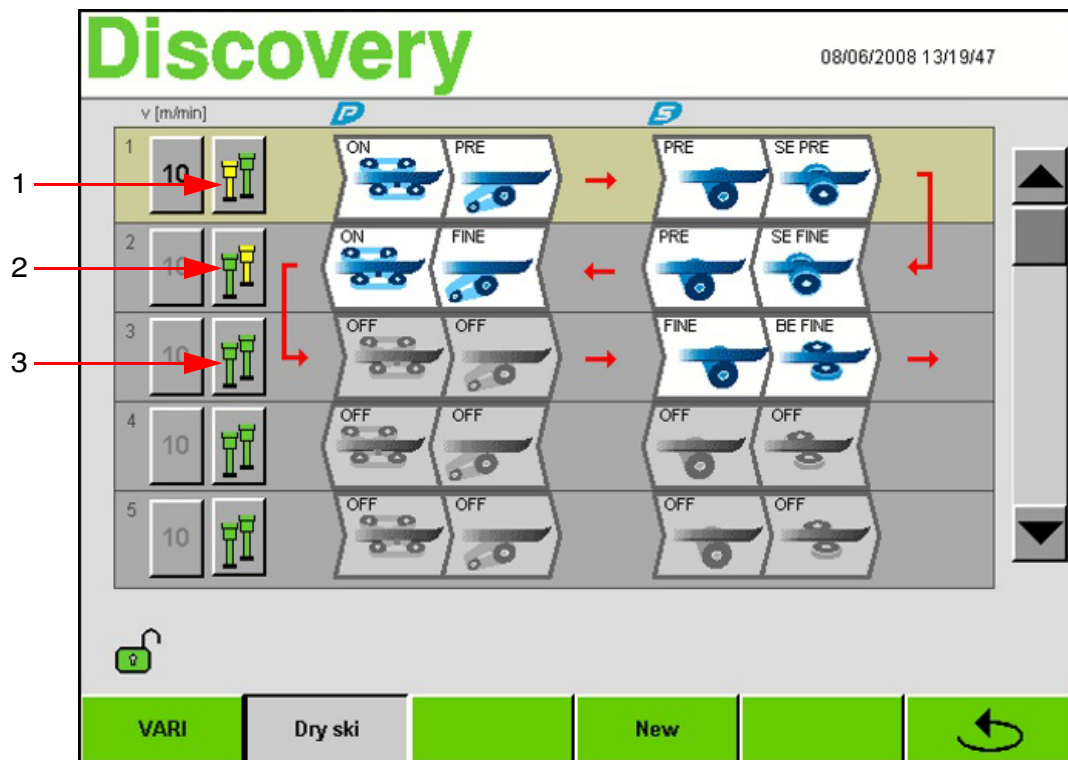

To enable an improved grinding with snowboards that are not plane, the holding-down pressures for each processing stage can be set differently and saved in the snowboard program.

- The holding-down pressure can be set for the front and the back by pressing the respective buttons.
 - 1) Holding-down device, front => LOW (reduced pressure, displayed in yellow)
Holding-down device, back => HIGH (standard holding-down pressure, displayed in green)
 - 2) Holding-down device, front => HIGH
Holding-down device, back => LOW
 - 3) Holding-down device, front => HIGH
Holding-down device, back => HIGH

10.4 Module PREGRIND - Change parameters



i The most important parameters are shown on the main screen on the graphic of the module PREGRIND during operation.

- Angle adjustment SEG
- Grinding rpm SEG/BELT
- Grinding force SEG/BELT
- Processes SEG/BELT (x of y)

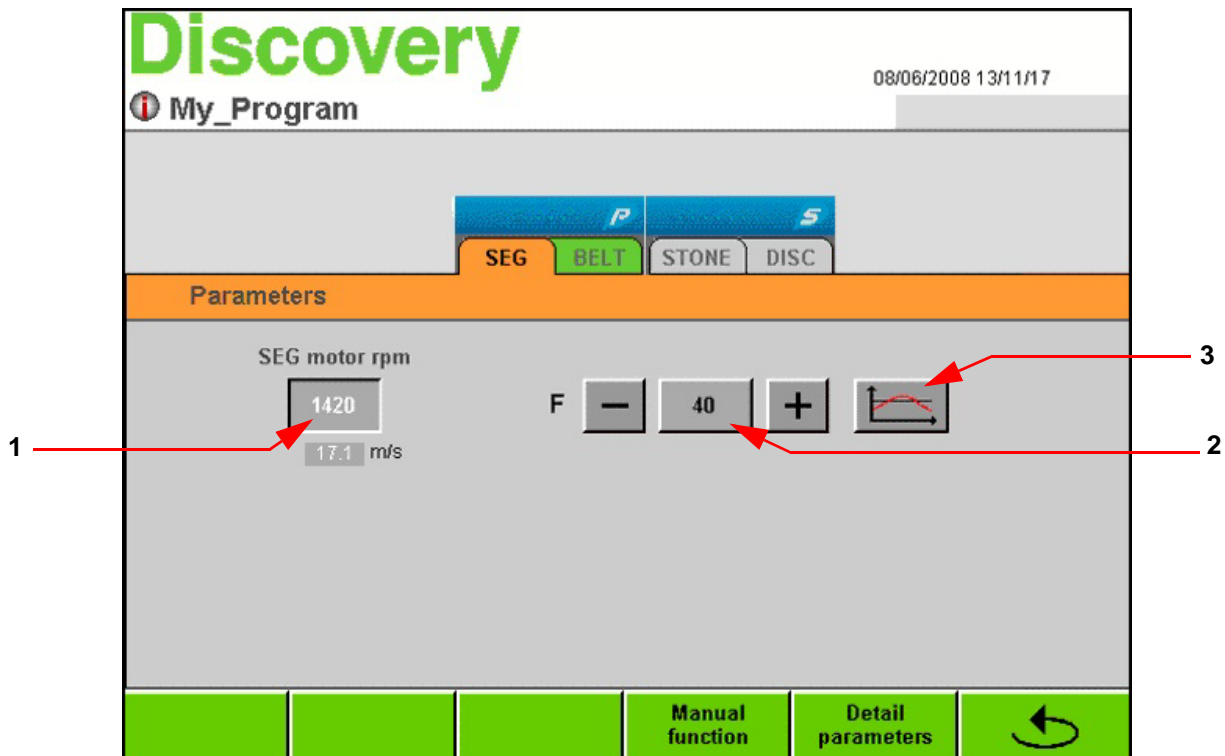

- Actuate the register "SEG" to call up the SEG-parameters.

10.4.1 Parameters SEG

Speed of SEG motor [1]

- The speed of the SEG motor is shown in the field [1]. The field below shows the cutting speed in meters per second [m/s].

Grinding force SEG [2]

- Base force (in N) for the SEG can be entered by actuating the field [2].

i The value can also be raised or reduced by actuating the keys +/-.

Variable grinding pressure [3]

- [see chapt. 11 Variable grinding force, page 74.](#)

10.4.1.1 Detail parameters SEG

- By actuating the key "Detail parameters" further SEG parameters can be changed.

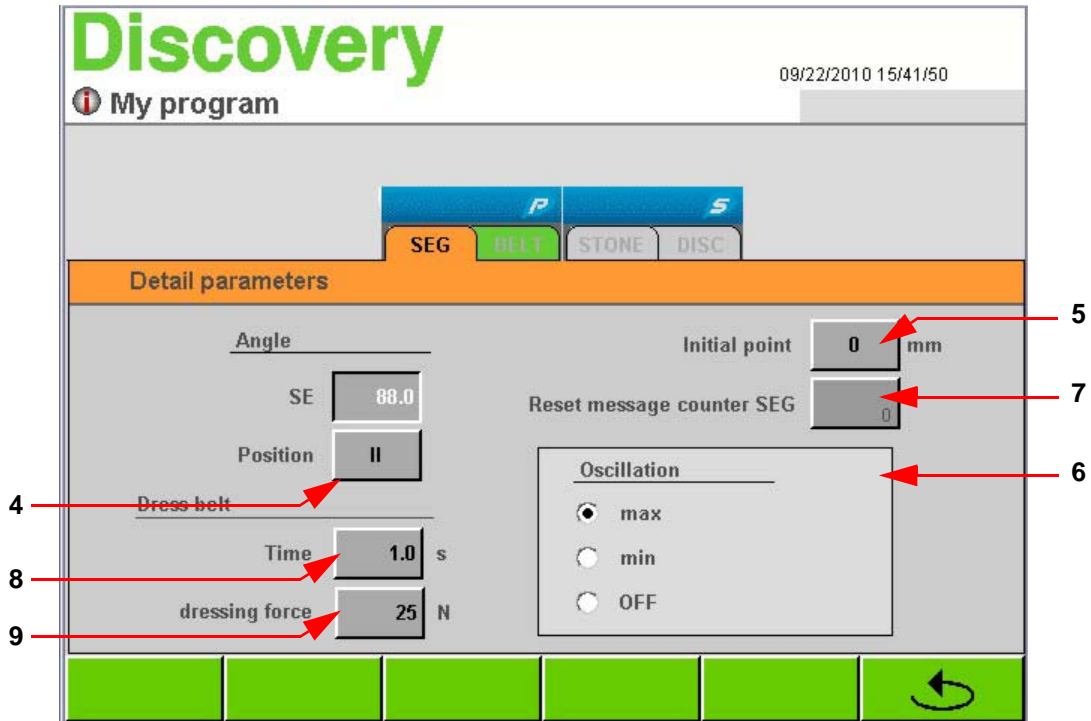

Position [4]

- By actuating the field "Position" [4] you can select between four different angle settings. The angles for the base edge, side edge and the effective edge angle are shown above this field.

i This angle adjustment is only for information and is not adopted automatically to the SEG unit. Actual grinding angle is to be adjusted manually ([see chapt. 6.3.1 Adjustment of the grinding angle SEG, page 24](#)).

Initial point [5]

- This function allows variation of initial points for grinding eg. for rental skis.
- By entering in the field „Initial point“ eg. +20, the SEG sets in 20 mm in front of the set start position and sets off 20 mm behind the set end position.

i Adjustment area is between +50 and -100 mm for both parameters. For negative values enter first the number, then the minus.

Oscillation SEG [6]

- Selection of maximum or minimum oscillation (particularly for board with binding or children skis) for belt or deactivation of oscillation.

By actuating the key "" this screen is left and the menu of module parameters is opened again.

Reset message counter SEG [7]

- The message counter should be reset after changing the belt by actuating the key [7].

- The counter reminds you by moving screen of checking or changing the belt after a preset number of skis were ground. The counter is reset to "0" by actuating the moving message or by actuating the key "Reset message counter SEG" [7].

Belt dressing time [8]

- The time for belt dressing is preset by pressing button [8]. This function is activated by pressing the "Dress belt" button in the "Manual function" window.

Belt dressing force [9].

- The clamping force in Newton for belt dressing against the belt dressing stone is set in the input field "Belt dressing force".

10.4.1.2 Manual functions SEG

- The menu for manual functions of SEG is opened by actuating the key "Manual functions" in the screen "Parameters SEG".

 This function can not be called up during grinding process!

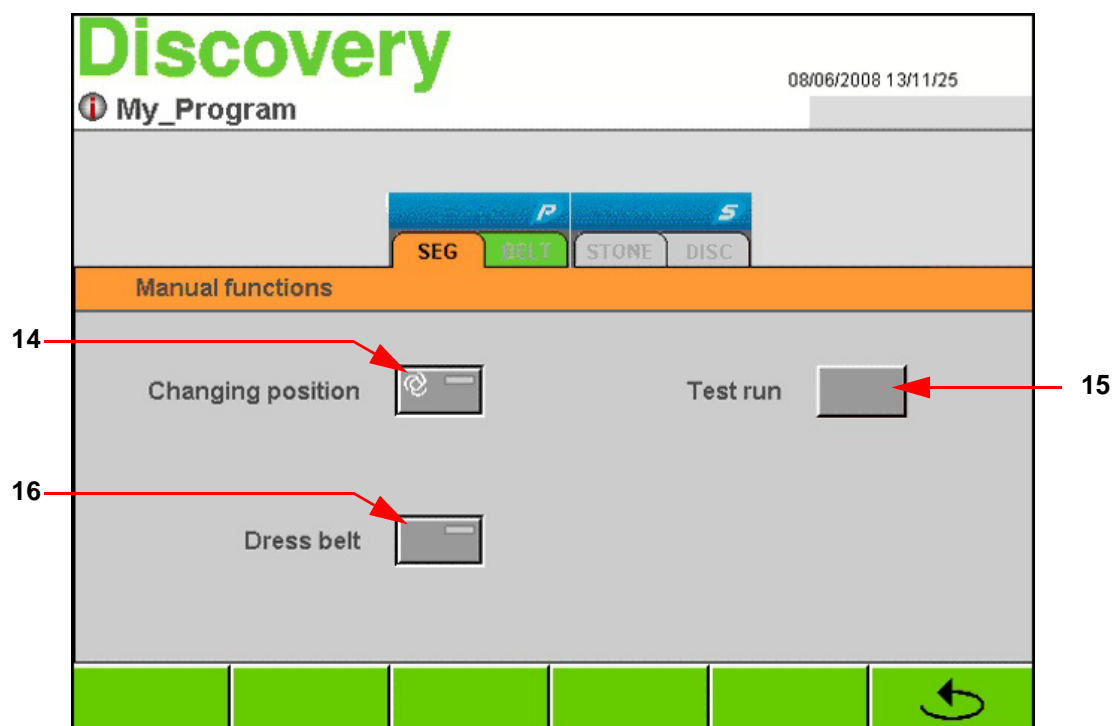

Changing position SEG [14]

- By actuating the key "Changing position", left and right SEG units move to front position to guarantee optimum belt change - [see chapt. 14.2.1 Changing the grinding belt SEG, page 97](#)

 The yellow status lamp in the key signals achieved changing position!

Test run [15]

- As long as the key "Test run" is pressed, the two SEG motors run for example checking the belt run.

Belt dressing [16]

Prior to softening the grinding belts, the belt dressing unit must be mounted on the side edge grinder [\(see chapt. 14.2.2 Dressing the SEG belt, page 97\)](#).

- Pressing the "Dress belt" button will cause the two grinding belts to be softened for the pre-set time.

10.4.2 Parameters belt unit

- Actuate the register "BELT" to call up the belt parameters.

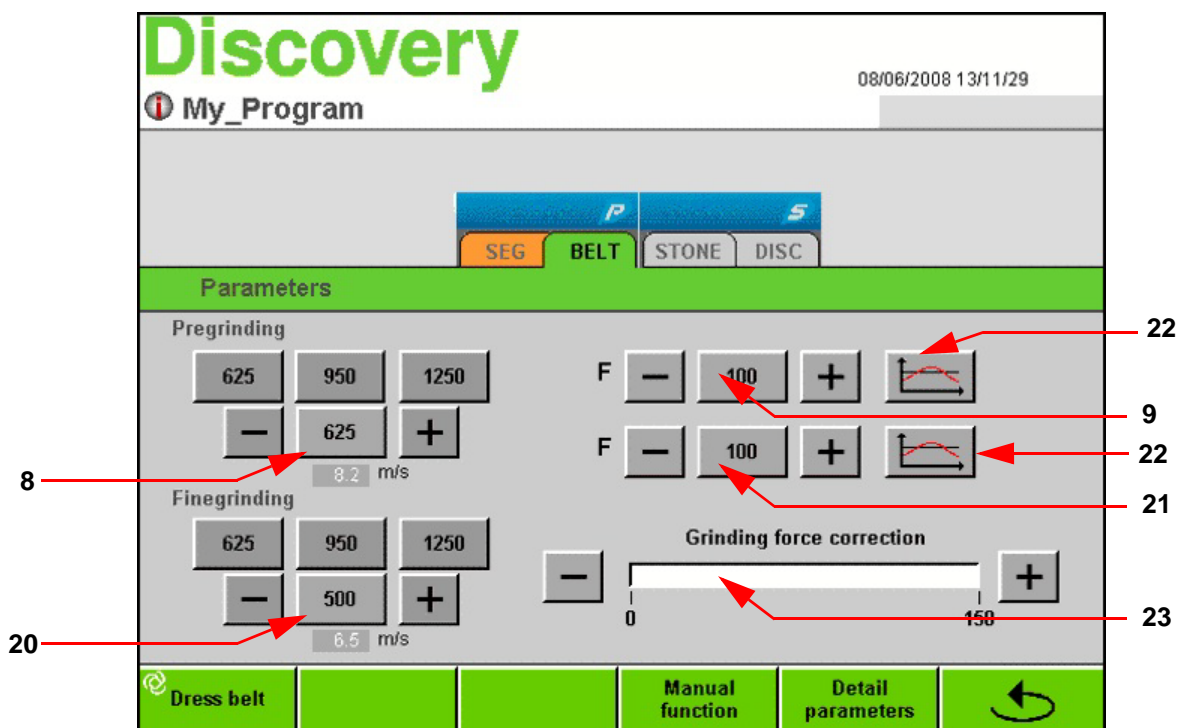

Pre-grinding speed [8]

- Actuate the "pre-grinding speed" input field. Change the pre-grinding speed using the number pad and confirm with "ENTER". The field below displays the cutting speed in meters per second.
- Furthermore, you are able to select pre-specified speeds using the buttons above.

Pre-grinding force [9]

- This input field is used to enter the basic force for the belt pre-grinding in Newton.

Fine grinding speed [20]

- Actuate the "pre-grinding speed" input field. Change the fine grinding speed using the number pad and confirm with "ENTER". The field below displays the cutting speed in meters per second.
- Furthermore, you are able to select pre-specified speeds using the buttons above.

Fine grinding force [21]

- This input field can be used to enter the basic force for belt fine grinding in Newton.

Variable grinding pressures [22]

- [see chapt. 11 Variable grinding force, page 74.](#)

Correction of grinding force [23]

- The continuous abrasion wear of the grinding belt can be compensated by the grinding force correction.
- Actuate key [+] to adjust a correction of belt grinding force up to 150 newton. This adjustment is adopted to all programs.



This correction is not specifically stored to a separate program. By actuating the function „Dress belt“ the grinding force correction is automatically reset to „0“.

10.4.2.1 Detail parameters belt unit

- By actuating the key "Detail parameters" further belt parameters can be changed.

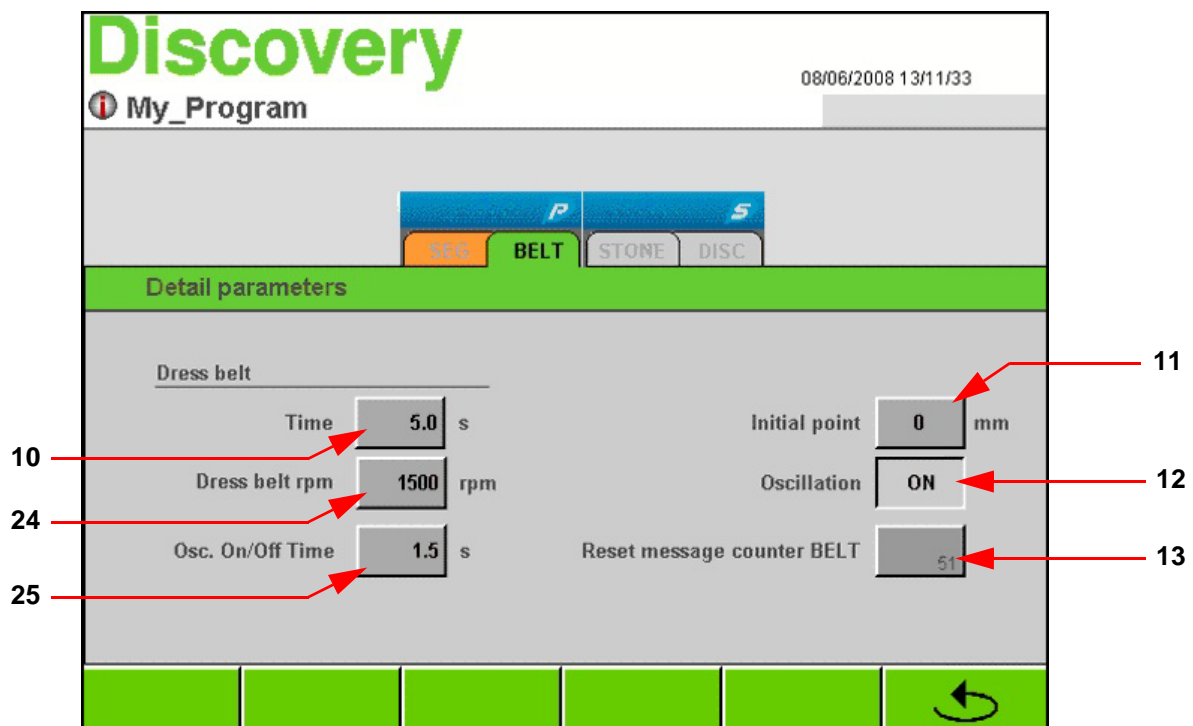

Belt dressing time [10]

- The time for belt dressing can be preset by actuating the key [10]. Belt dressing is activated by pressing the key "Dress belt" in the menu "Manual functions".

Belt dressing rpm [24]

- The speed of the belt during the belt dressing can be preset in the input field "Belt dressing rpm".

Oscillation On / Off [25]

- The oscillation time of the belt dressing stone is specified in the input field "Oscillation time On / Off".

Initial point [11]

- This function allows variation of initial points for grinding eg. for rental skis.

- By entering in the field „Initial point“ eg. +20, the belt unit sets in 20 mm in front of the set start position and sets off 20 mm behind the set end position.

i Adjustment area is between +50 and -100 mm for both parameters. For negative values enter first the number, then the minus.

Oscillation [12]

- Activation or deactivation of belt oscillation: ON/OFF.

By actuating the key "↶" this screen is left and the menu of module parameters is opened again.

Reset message counter BELT [13]

- The message counter should be reset after changing the belt by actuating the key [13].

The counter reminds you by moving screen of checking or changing the belt after a preset number of skis were ground. The counter is reset to "0" by actuating the moving message or by actuating the key "Reset message counter BELT" [13].

10.4.2.2 Manual functions belt unit

- The menu for manual functions of the belt unit is opened by actuating the key "Manual functions" in the screen "Parameters BELT".

i This function can not be called up during grinding process!

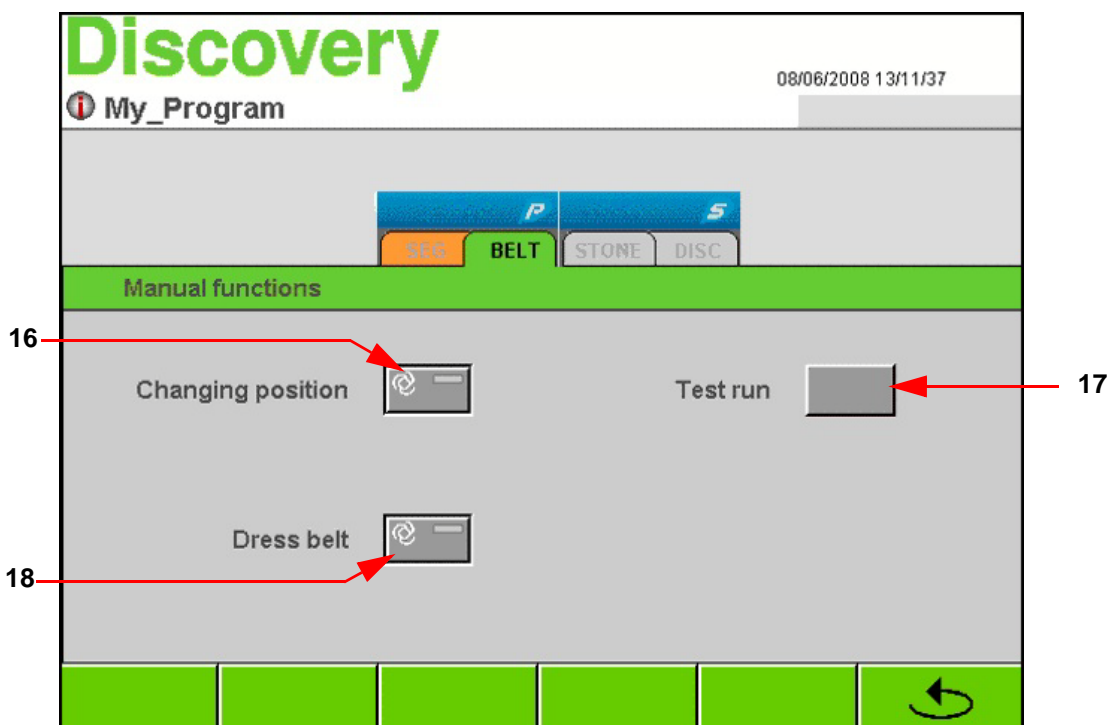

Changing position belt [16]

- By actuating the key "Changing position", the belt unit moves to front position to guarantee optimum belt change - see [chapt. 14.2.3 Changing the grinding belt of belt unit, page 98](#).

Test run [17]

- As long as the key "Test run" is pressed, the belt unit starts-up.

Belt dressing [18]



New grinding belts have to be dressed before use to avoid damaging of the ski base and to guarantee optimum application!

- By actuating the key "Dress belt" the belt is dressed with the preset time. Additionally the grinding force correction is automatically reset to „0“!

10.5 Stone unit - change parameters



i The most important parameters are shown on the main screen on the graphic of the module STONE during operation.

- Kind of structure
- Dressing speed
- Angle adjustment disc
- Grinding rpm stone/disc
- Grinding force stone/disc
- Processes stone/disc (x of y)

10.5.1 Reduce grinding force for children ski

- Select between normal and reduced grinding force by pressing the arrow [A] on the main screen.
 - Small arrow -> low grinding force
 - Large arrow -> normal grinding force

! It is imperative that the grinding force is reduced to avoid damages to the children ski!

10.5.2 Speed parameters

- By touching the graphics of the respective module STONE on the main screen, the menu of the module parameters is opened.

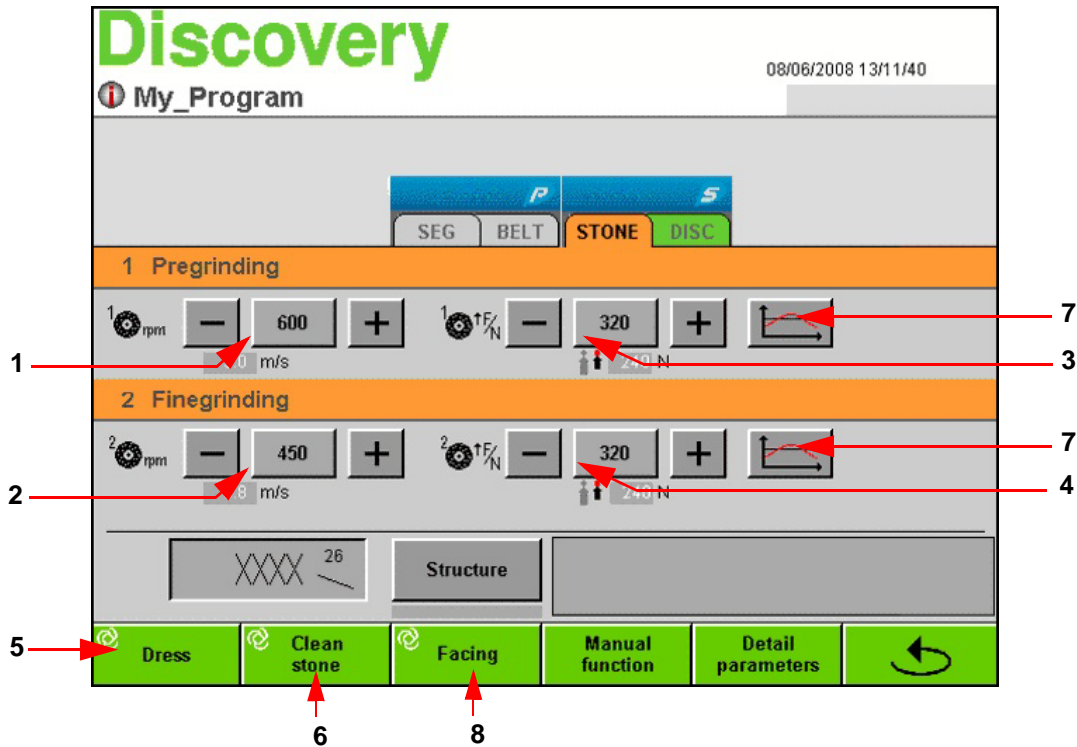

- Actuate the register "STONE" to call up the stone parameters.

Pre-grinding speed [1]

- Actuate the field "Pre-grinding speed" [1]. Enter the desired speed with the number block and confirm with "ENTER". The field below shows the cutting speed in meters per second [m/s].

Grinding force pre-grinding [3]

- Base force (in N) for the stone pre-grinding can be entered by actuating the field [3].

Fine-grinding speed [2]

- Actuate the field "Fine-grinding speed" [2]. Enter the desired speed with the number block and confirm with "ENTER". The field below shows the cutting speed in meters per second [m/s].

Grinding force fine-grinding [4]

- Base force (in N) for the stone fine-grinding can be entered by actuating the field [4].



The values can also be raised or reduced by actuating the keys +/-.

Stone dressing [5]

- By actuating the key "Dress" the stone is dressed with the preset parameters.

Stone cleaning [6]

- As long as the key "Clean stone" is pressed, the stone is cleaned with the stone cleaner.



After stone dressing the cleaning process is carried out automatically!

Variable grinding pressure [7]

- [see chapt. 11 Variable grinding force, page 74](#)

Stone facing [8]

- By actuating the key "Facing" the stone is faced with a fine cross structure. This guarantees the same start situation for every applied structure.

10.5.2.1 Detail parameters stone unit

- By actuating the key "Detail parameters" further stone parameters can be changed.

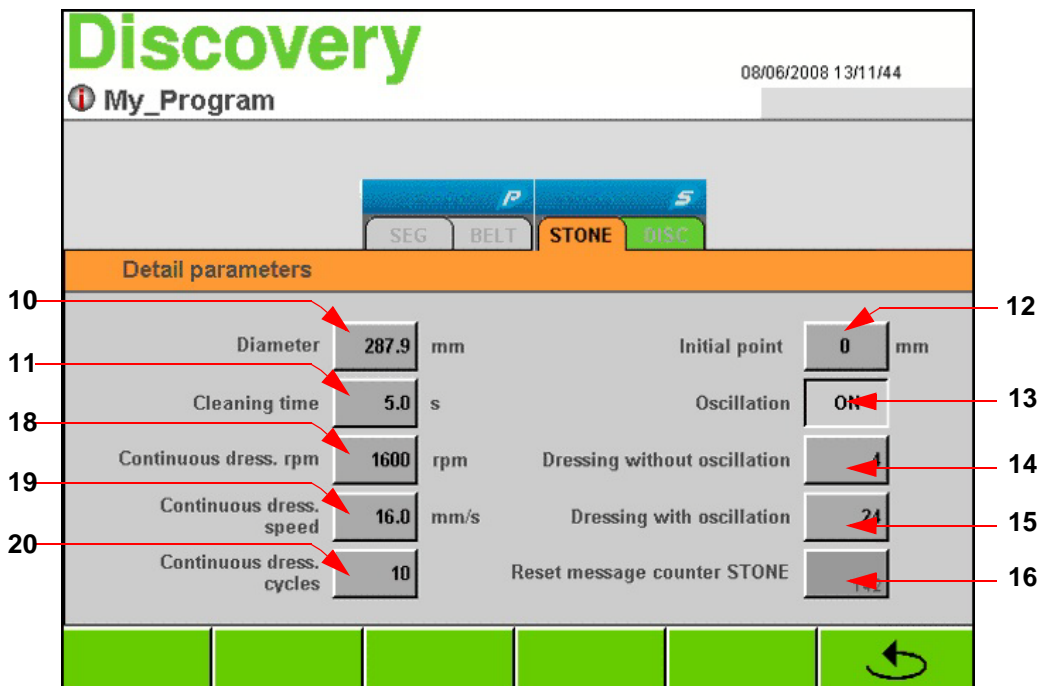

Stone diameter [10]

- [see chapt. 10.5.6 Check and adapt stone diameter, page 68](#)

Cleaning time [11]

- In this input field you can enter the stone cleaning period (0-9 sec.) after the dressing process (entering "0" deactivates the stone cleaner).



Information for the continuous dressing

During continuous dressing, ensure that the water cooling is sufficient. Maximum stone speed of 1300 – 1800 rpm. Dressing speed of approx. 18 – 23 mm/sec. If not observed, there is also a risk that the diamond will anneal out.

Continuous dressing rpm [18]

- The stone speed (rpm) during continuous dressing is specified in this input field.

Continuous dressing speed [19]

- The dressing speed during continuous dressing is specified in this input field.

Continuous dressing moves [20]

- The number of dressing procedures during continuous dressing is specified in this input field.

Initial point grinding stone [12]

- This function allows variation of initial points for grinding eg. for rental skis.
- By entering in the field „Initial point“ eg. +20, the stone unit sets in 20 mm in front of the set start position and sets off 20 mm behind the set end position.



Adjustment area is between +50 and -100 mm. For negative values enter first the number, then the minus.

Oscillation [13]

- Selection of oscillating or non-oscillating stone. Use e.g. for straight structure.



The stone is dressed automatically from time to time to avoid groove formation in the stone by the steel edges.

Dressing cycles without stone oscillation [14]

- The stone is dressed after the input number of processes was reached, with adjustment [Oscillation off].



Not enough dressing cycles may cause groove formation on the stone, eg.: for middle-related structures as arrow structure, arrow structure with indentation or wave structure.

Dressing cycles with stone oscillation [15]

- The stone is dressed after the input number of processes was reached with adjustment [Oscillation on].

By actuating the key " " this screen is left and the menu of stone parameters is opened again.

Reset message counter STONE [16]

- The message counter is to be reset after stone changing by actuating the key [16].

After the message counter as reached a preset number of messages, a moving message orders you to check or change the grinding stone or diamond. The counter is reset to "0" by actuating the moving message or by actuating the key "Reset message counter" [16].

10.5.3 Structure selection

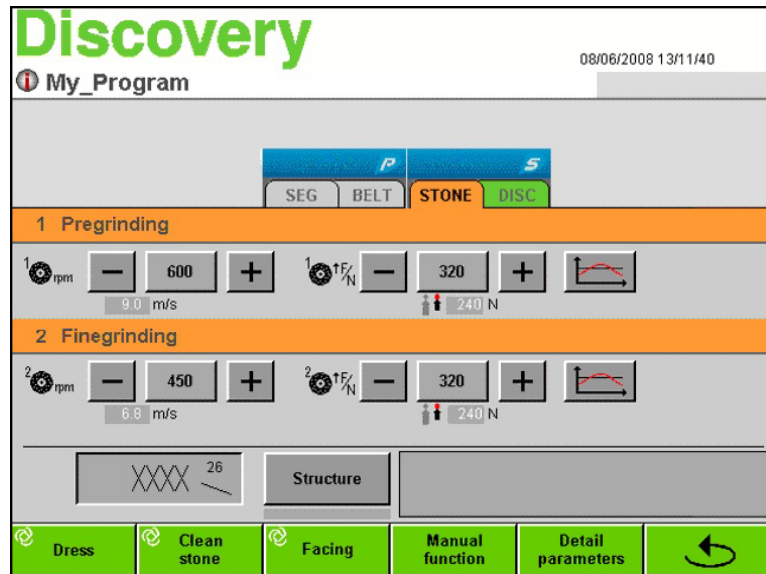

- The screen with the structure parameters is opened by actuating the key "Structure" in the window "Stone parameters".

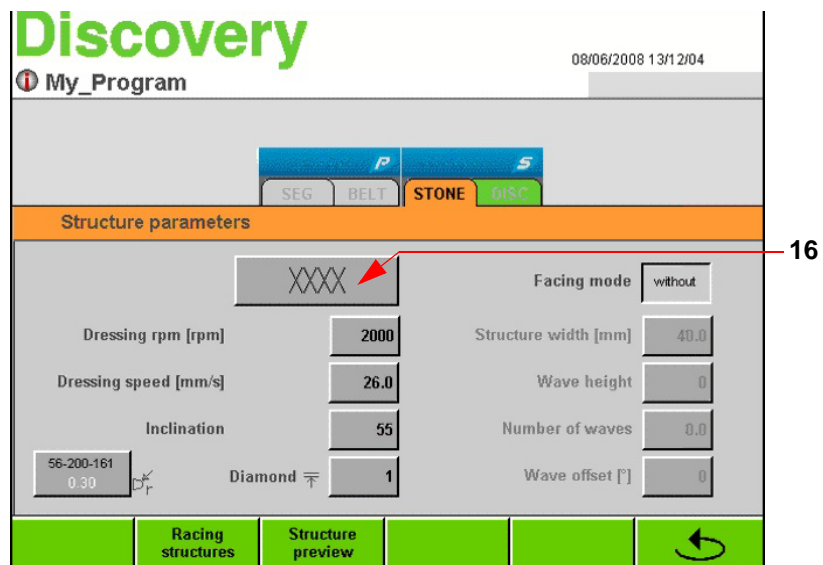

- By actuating the field "Structure" [16] another screen is opened where you can select the desired structure.

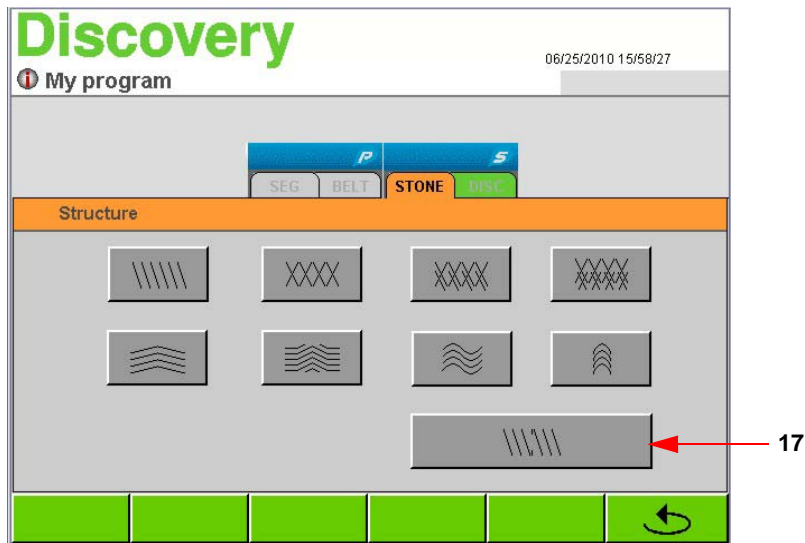

- By actuating the respective structure button the structure is adopted to the program.
- Adjustment of structure parameters [see chapt. 10.5.4 Structure parameters, page 60](#)
- Split structures can be selected by actuating the field [17].

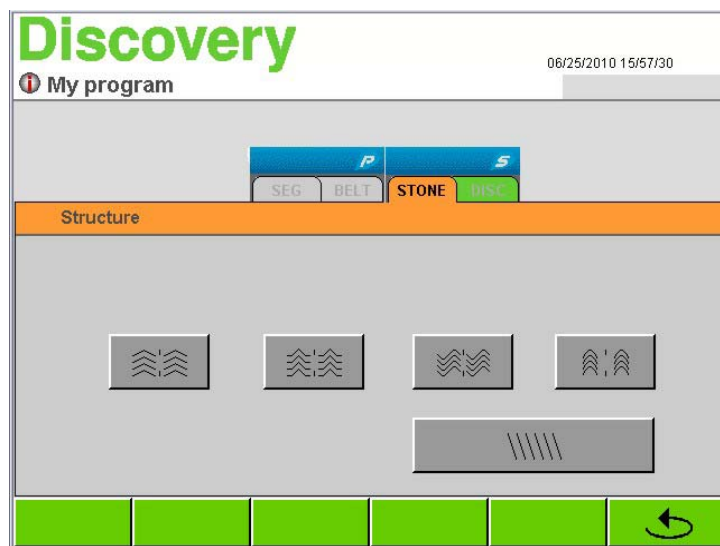

- V, arrow or wave structures are adjusted with split structures.
- The selected structure is applied to both sides of the stone. So that this structure is available for front and back feed system.
- Adjustment of structure parameters [see chapt. 10.5.4 Structure parameters, page 60](#)
- By actuating the respective structure button the structure is adopted to the program.

10.5.4 Structure parameters

Following parameters can be adjusted after selection of the desired structure.

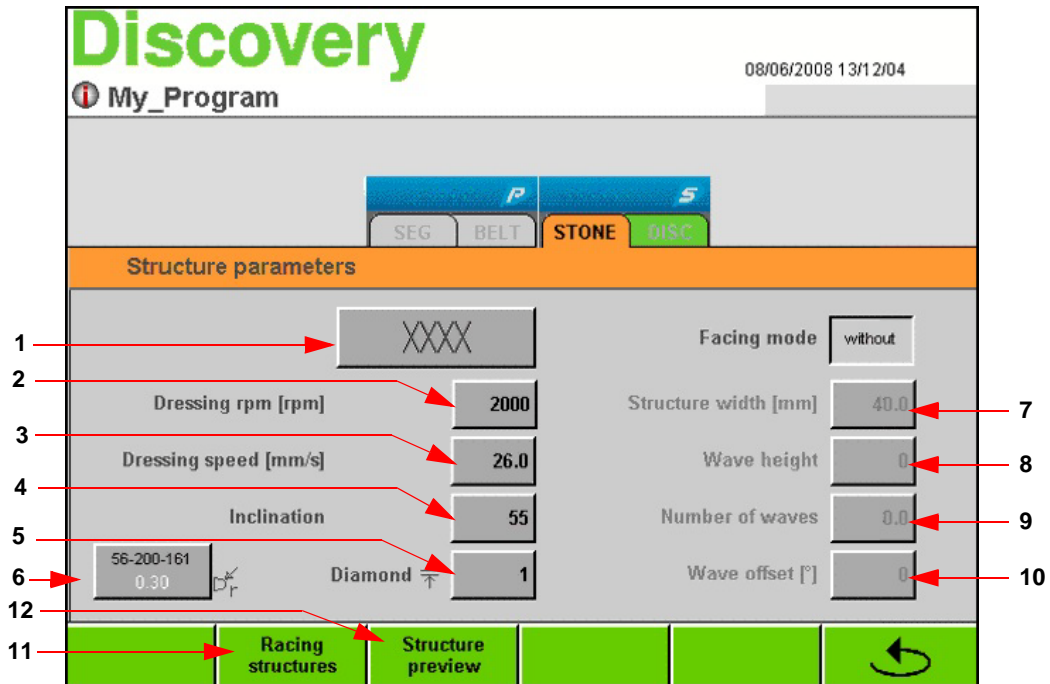

Structure [1]

- The selected structure is shown in the field "Structure".

Dressing rpm [2]

- The speed of the grinding stone during dressing process is entered in the field "Dressing rpm".

Adjustment area is between 600 and 2000 rpm.

Dressing speed [3]

- The speed of the dressing diamond is entered in the field "Dressing speed".

Adjustment area is between 3 and 35 mm/s.

Structure inclination [4]

- Structure inclination of the selected structure (except linear structure and wave structure) can be entered by actuating this field.

for example

- Value higher than 60: steeper structure
- Value lower than 60: flatter structure
- Value 0: straight-crossed structure



This value is not indicated in degrees!

Structure depth (diamond feed) [5]

- The structure depth can be entered in feed steps 1 - 3 by actuating the field "Diamond feed".
1 feed step has a depth of 0.02 mm.

Diamond selection [6]

- The diamond type that is used must be selected in order to attain agreement between the structure preview and the actual grinding pattern on the ski.

Structure width [7]

i This parameter can only be adjusted for V-structure with indentation!

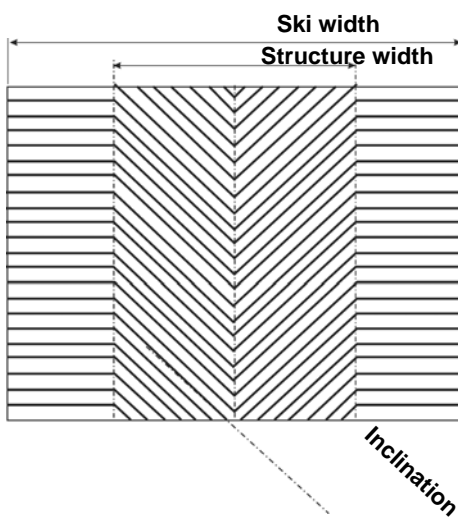

- The structure width means the width of the V - see drawing.

i Depending on input of inclination - positive or negative value, the structure changes to V or arrow structure.

i Following parameters can only be adjusted for wave structure!

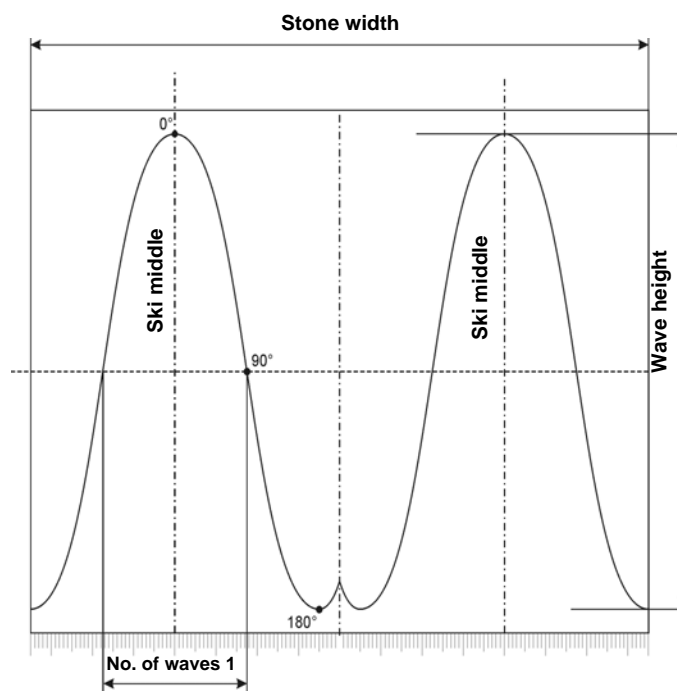

Wave height [8]

- The wave height can be entered by actuating the key "Wave height". A negative value e.g. -100 reflects the wave around the horizontal axis.



The wave height also depends on the feed speed and the grinding rpm.

Number of waves [9]

- The number of waves over the ski width can be entered by actuating the field "Number of waves".

Wave position [10]

- Wave position can be changed by actuating the field „Wave offset“.

e.g.: With an input of 0° the maximum of the wave is situated in the middle of the structure. With an input of 180° the minimum of the wave is in the middle of the structure. When entering a „Wave offset“ the structure on the stone gets asymmetric.



Dressing rpm, dressing speed and inclination have to be set for both, left and right stone half, when working with split structures.

10.5.4.1 Chevron structure

The screenshot shows the 'Discovery' control interface. At the top, it says 'Discovery' in green, with a date '06/25/2010 15:56/46' on the right. Below that is 'My program' with an information icon. There are buttons for 'SEG', 'BELT', 'STONE', and 'DISC'. The 'STONE' button is highlighted in orange. Below this is the 'Structure parameters' section, which is highlighted in orange. It contains several fields: 'Margin Dressing speed' (5.0 mm/s), 'Facing mode' (always), 'Dressing rpm [rpm]' (1800), 'Structure width [mm]' (70.0), 'Dressing speed [mm/s]' (16.0), 'Wave height' (120), 'Inclination' (45), 'Number of waves' (1.0), 'Diamond' (1), and 'Wave offset [°]' (-15). A red arrow labeled '11' points to the 'Margin Dressing speed' field. At the bottom, there are buttons for 'Racing structures', 'Structure preview', and a refresh icon.

Margin dressing speed [11]

- For a chevron structure additionally the margin dressing speed [11] can be insertet. The input area is betwenn 3 and 30 mm/s. The smaller the insertet value, the finer and less visible is the structure in the margin area.

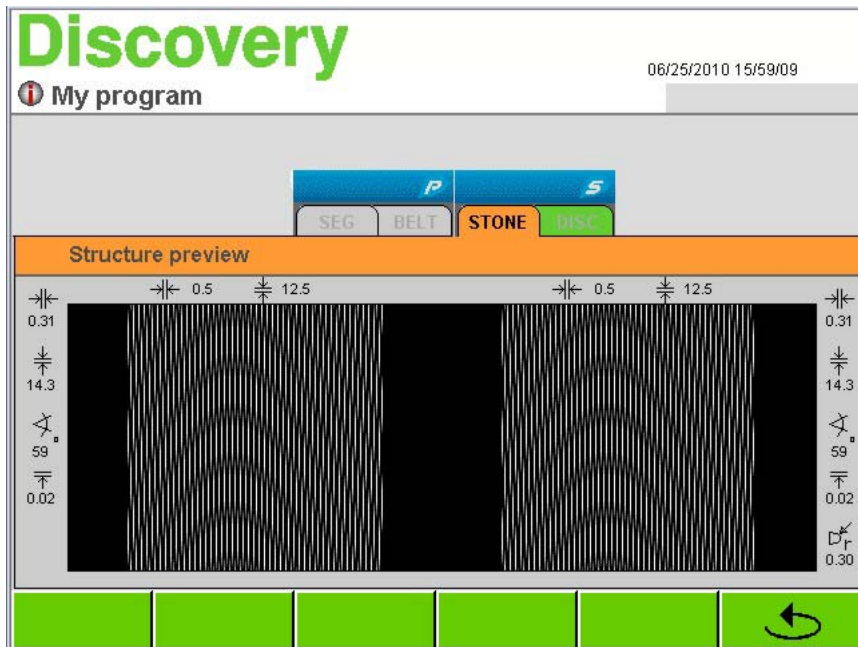

10.5.4.2 Racing structures

i Specific racing structures can be determined automatically based on the selection of snow/air temperature, type of snow, air humidity and discipline (Alpine and Nordic).

- The menu for racing structures is opened by actuating the key "Racing structure" [11] in the screen "Structure parameters".

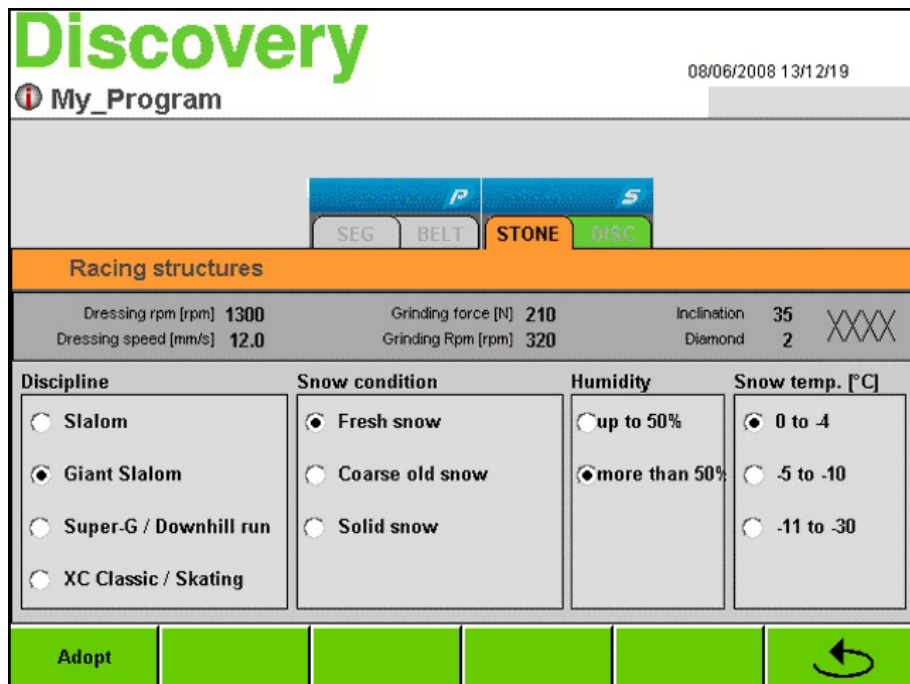

- Select the desired parameters.
- The grinding parameters calculated by the program are shown in the top line.
- The parameters are adopted to the program location selected before by actuating the key "Adopt".
- By actuating the key "↺" this screen is left without adopting the grinding parameters.
- This symbol "❄" " signals active racing structure.

i The symbol "Snowflake" is shown as long as you do not change any of the adopted racing parameters .

10.5.4.3 Structure preview

Most of the structures can be previewed.

- The structure preview is opened by actuating the key "Structure preview" [12] in the screen "Structure parameters".

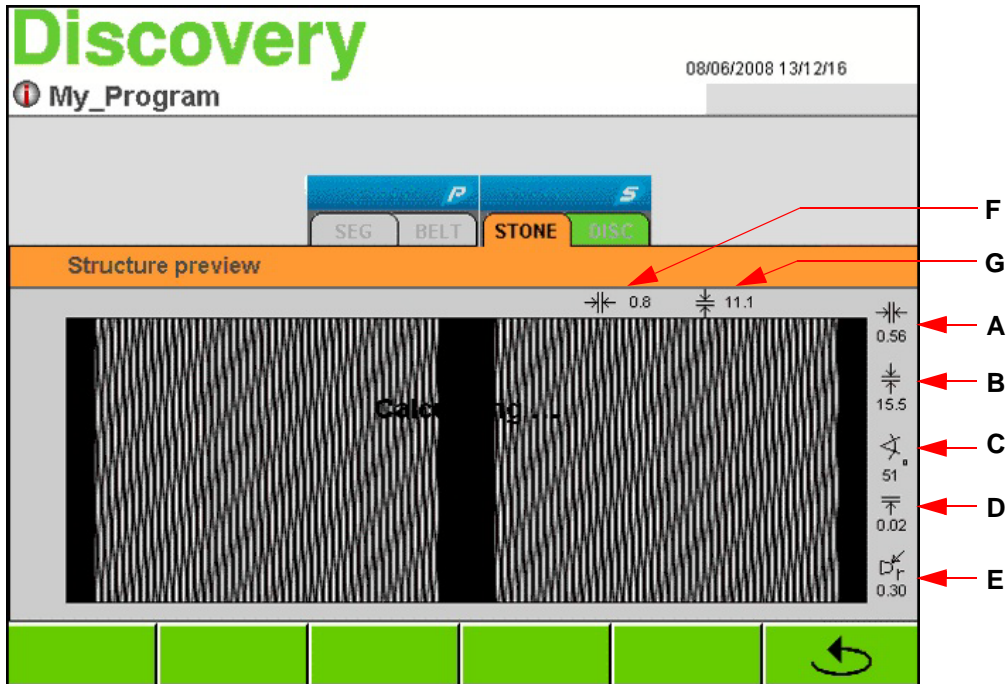

- The selected structure is graphically shown in this preview window.

Additionally the following structure information is shown:

- Groove width [A] in mm
- Groove length [B] in mm
- Structure inclination [C]
- Diamond feed [D] in mm
- Diamond radius [E] in mm
- Transverse shuttle distance [F] in mm
- Longitudinal shuttle distance [G] in mm

10.5.5 Manual functions stone unit

- The menu for manual functions of stone unit is opened by actuating the key "Manual functions" in the screen "Stone parameters".



This function can not be called up during grinding process!

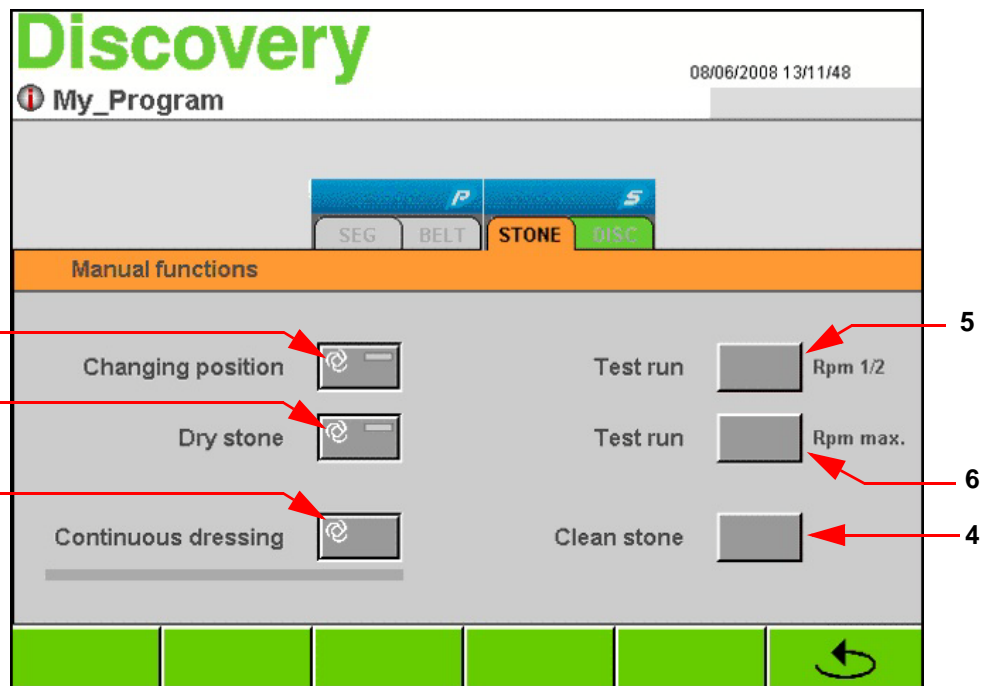

Changing position of stone [1]

- By actuating the key "Changing position", the stone unit and the diamond move to front position to guarantee optimum stone or diamond change.
Stone changing - [see chapt. 14.3.1 Changing the grinding stone, page 100](#)
Diamond changing - [see chapt. 14.3.2 Changing the diamond, page 101](#)

Drying grinding stone [2]

- The grinding stone should be spin-dried after it has not been used for longer periods or after cleaning the machine. The grinding stone is spin-dried with the preset parameters by pressing the button "Dry stone".
- e.g.: After cleaning the machine with the cleaning hose the grinding stone should be spin-dried by pressing this key (danger of unbalance).

Continuous dressing [3]

- The grinding stone is dressed with the parameters indicated in the "Detail parameters, stone" window by pressing the "Continuous dressing" button.

Clean stone [4]

- The stone is cleaned by the stone cleaner as long as the key "Clean stone" is pressed.

Test run rpm 1/2 [5]

- By actuating this key the stone motor is turned on/off with half speed 1000 rpm.

Test run rpm max [6]

- By actuating this key the stone motor is turned on/off with maximum speed 2000 rpm.
e.g. test run after stone changing.

10.5.6 Check and adapt stone diameter

i Because of the dressing cycles of the stone, the stone diameter decreases and therefore the swivel-in time and the grinding set-in point on the ski change. Generally the adjustment is performed automatically. However the screen "Pay attention to stone diameter" is shown automatically to check and eventually update the current stone diameter.

Stone diameter is to be corrected manually after following procedures:

- 1) Changing or resharpener the diamond
- 2) Changing the grinding stone
- 3) All work on the dressing unit of the stone slide

Input of the stone diameter

If the screen does not appear automatically, it can be opened with following steps:

- Actuate the graphics of the respective module STONE on the main screen.
- Actuate the register "STONE" to call up the stone parameters.

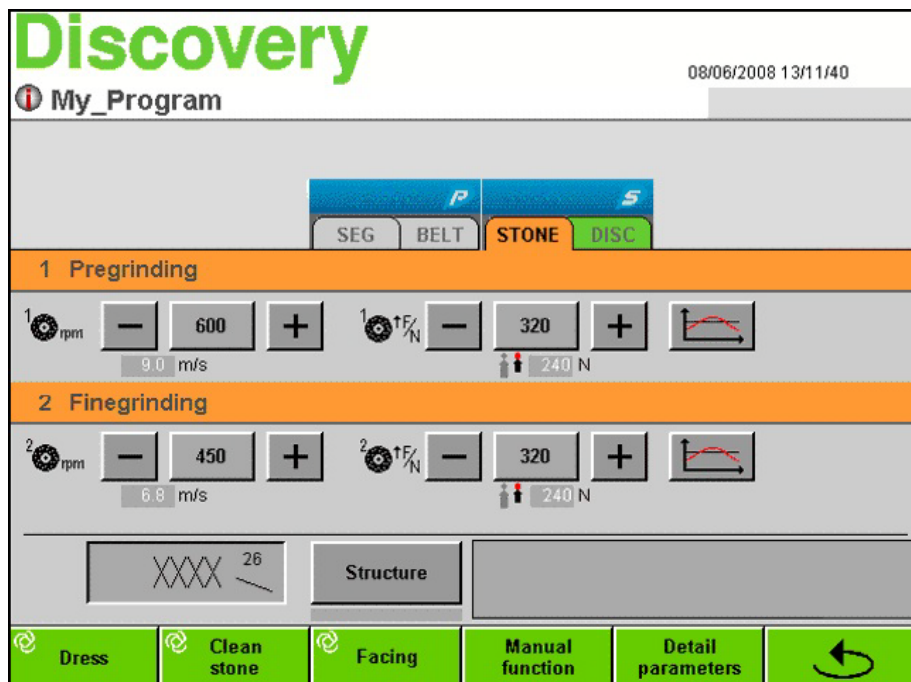

- The screen "Detail parameters" of the stone unit is opened by actuating the key "Detail parameters".

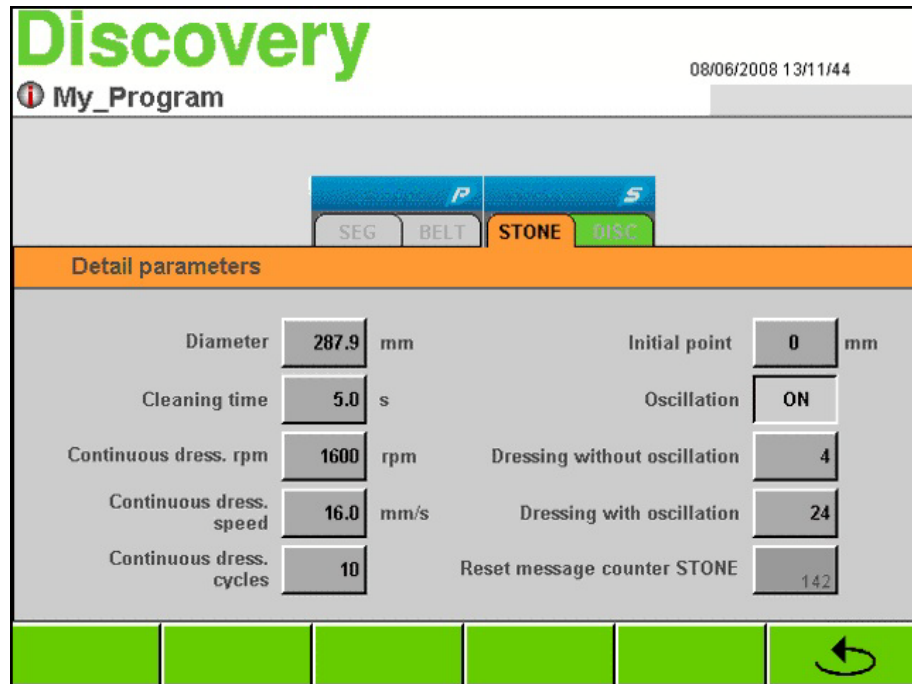

The stone diameter is shown in the field "Diameter". If this value (in mm) and the measured stone diameter do not match, the value has to be corrected.

- Actuate the field "Diameter".
- Enter the measured value (in mm) by the number block and confirm with "ENTER".

10.6 Disc unit - change parameters

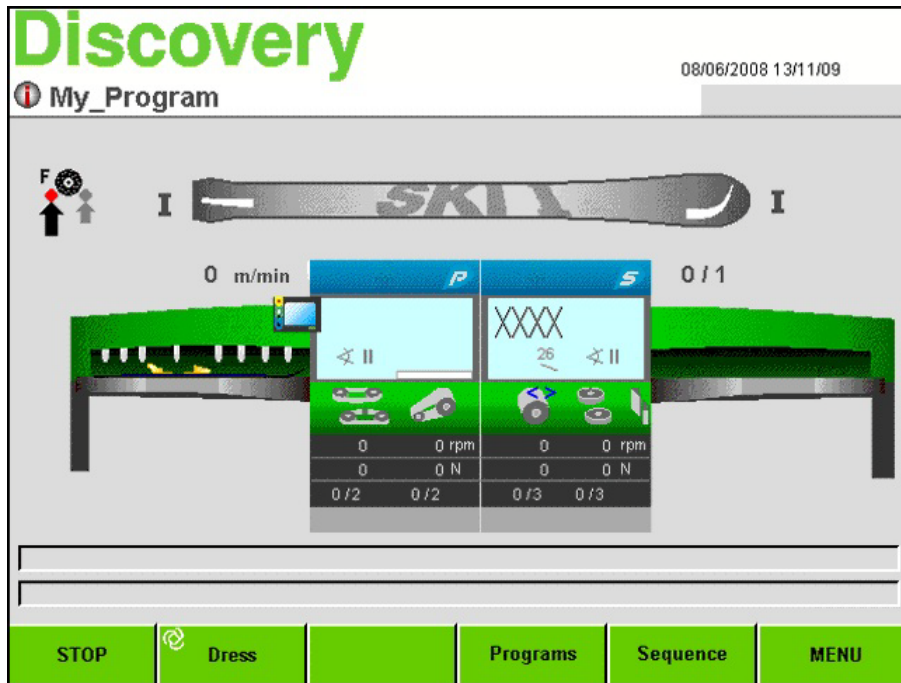

- By touching the graphics of the respective module STONE on the main screen, the menu of the module parameters is opened.

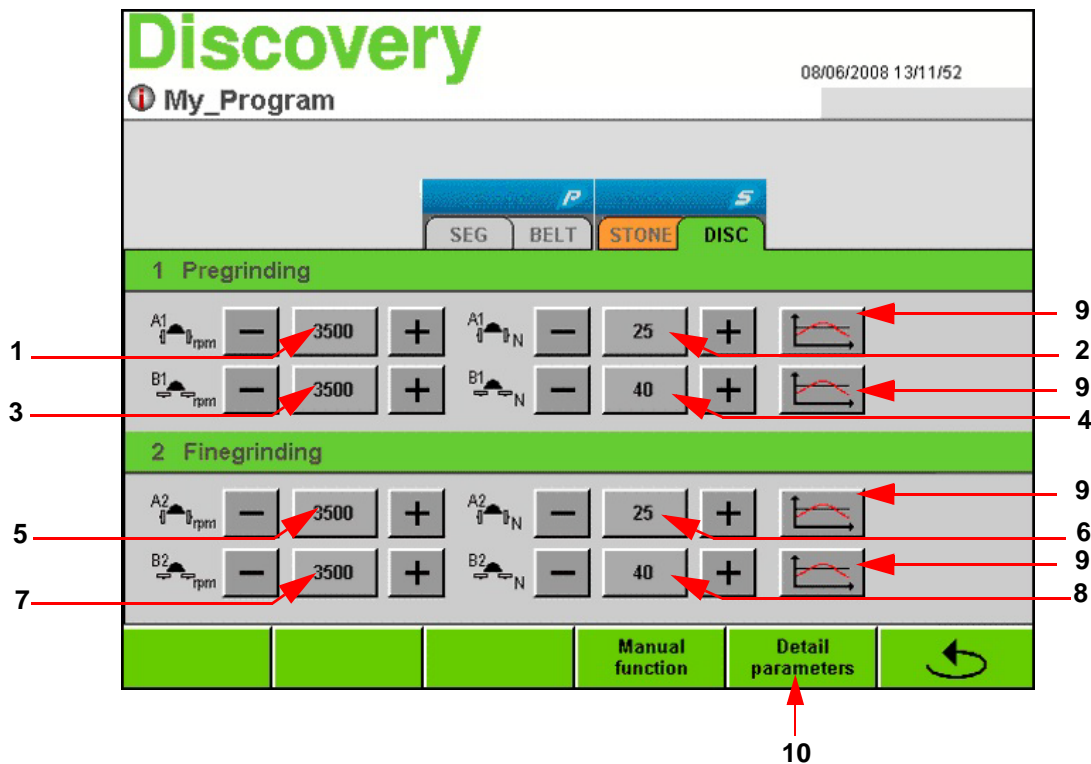

- Actuate the register "DISC" to call up the disc parameters.

10.6.1 Disc parameters

Pre-grinding speed SE [1]

- Actuate the field "Pre-grinding SE" [1]. Enter the desired speed with the number block and confirm with "ENTER".

Grinding force pre-grinding SE [2]

- Base force (in N) for the SE pre-grinding can be entered by actuating the field [2].

Pre-grinding speed BE [3]

- Actuate the field "Pre-grinding BE" [3]. Enter the desired speed with the number block and confirm with "ENTER".

Grinding force pre-grinding BE [4]

- Base force (in N) for the BE pre-grinding can be entered by actuating the field [4].

Fine-grinding speed SE [5]

- Actuate the field "Fine-grinding speed SE" [5]. Enter the desired speed with the number block and confirm with "ENTER".

Grinding force fine-grinding SE [6]

- Base force (in N) for the SE fine-grinding can be entered by actuating the field [6].

Fine-grinding speed BE [7]

- Actuate the field "Fine-grinding speed BE" [5]. Enter the desired speed with the number block and confirm with "ENTER".

Grinding force fine-grinding BE [8]

- Base force (in N) for the BE fine-grinding can be entered by actuating the field [8].



The values can also be raised or reduced by actuating the keys +/-.

Variable grinding pressure [9]

[see chapt. 11 Variable grinding force, page 74](#)

10.6.1.1 Detail parameters disc unit

- By actuating the key "Detail parameters" [10] further disc parameters can be changed.

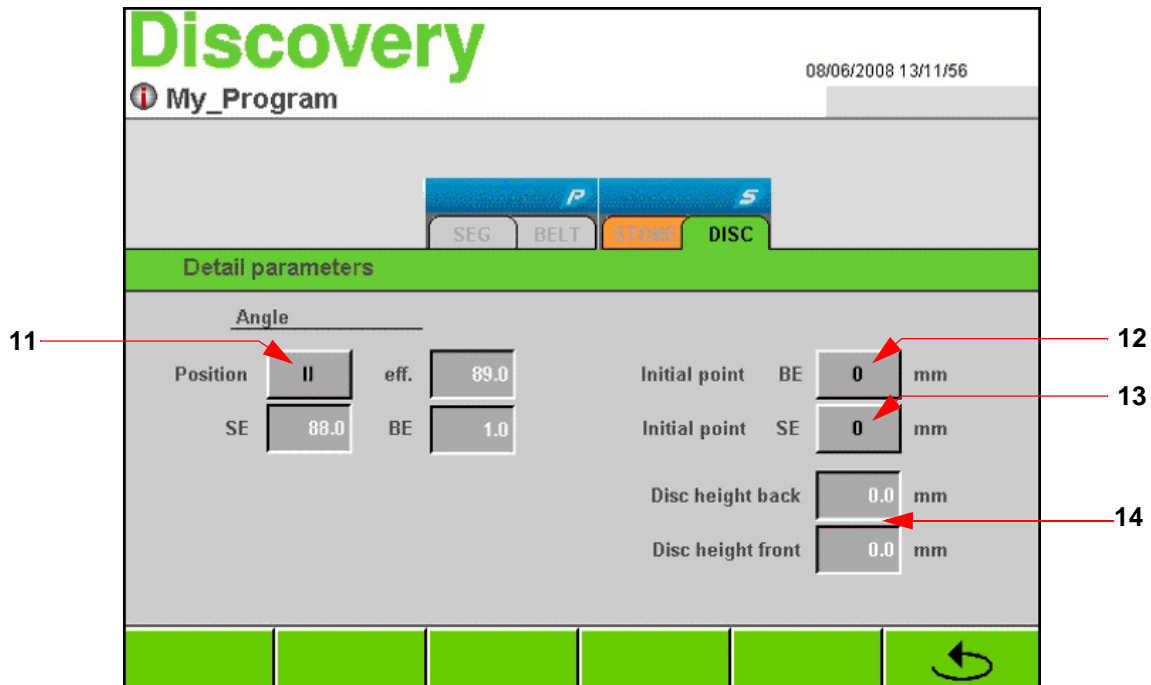

Position [11]

- By actuating the field "Position" four different angle adjustments can be selected. The grinding angle for base edge, side edge as well as the effective edge angle are shown above.

i This angle adjustment is only for information and is not adopted automatically to the disc unit. Actual grinding angle is to be adjusted manually ([see chapt. 6.4.1 Adjustment of the grinding angle disc. page 26](#)).

Initial point BE [12]

- This function allows variation of initial points for grinding eg. for rental skis.
- By entering in the field „Initial point BE“ eg. -50, the disc unit for base edge processing sets in 50 mm behind the set start position and sets off 50 mm in front of the set end position.

Initial point SE [13]

- By entering in the field „Initial point SE“ eg. +20, the disc unit for side edge processing sets in 20 mm in front of the set start position and sets off 20 mm behind the set end position.

i Adjustment area is between +50 and -100 mm for both parameters. For negative values enter first the number, then the minus.

Abrasion control discs [14]

- These two output fields show the current width of the front and rear disc. You will be informed by a message on the screen when the discs are nearly used up.

10.6.2 Manual functions disc unit

- The menu for manual functions of the disc unit is opened by actuating the key "Manual functions" in the screen "Parameters DISC".



This function can not be called up during grinding process!

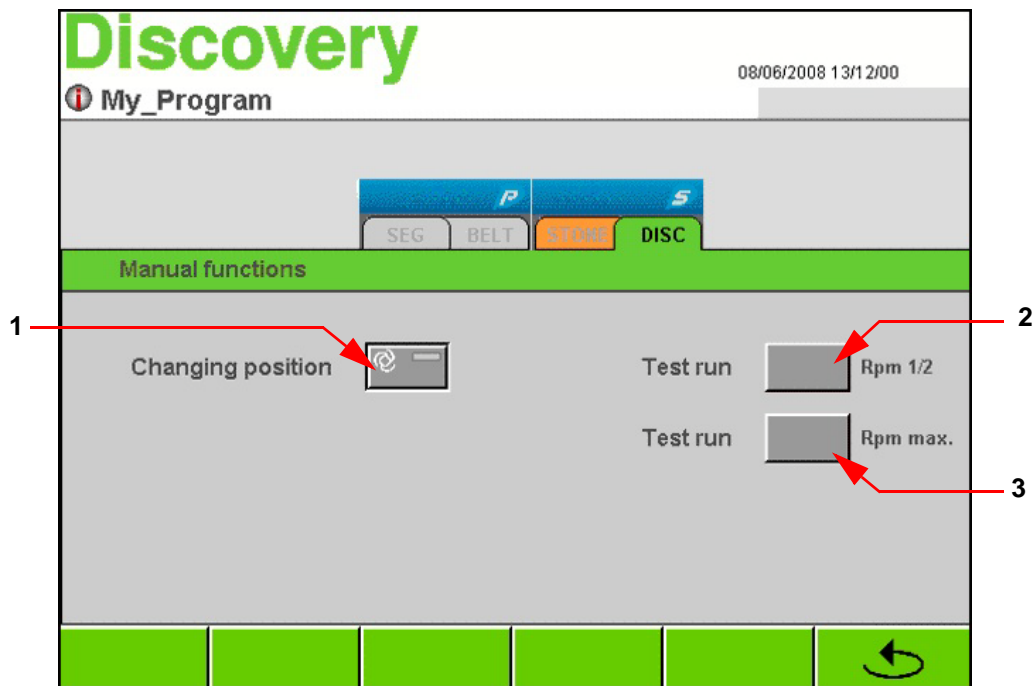

Changing position of disc [1]

- By actuating the key "Changing position", the disc units moves to front position BE grinding to guarantee optimum disc change - [see chapt. 14.3.3 Changing the ceramic discs, page 102.](#)

Test run rpm 1/2 [2]

- By actuating this key the disc motors are turned on/off with half speed 2250 rpm.

Test run rpm max [3]

- By actuating this key the disc motors are turned on/off with maximum speed 4500 rpm.
e.g. test run after disc changing.

11 Variable grinding force

To guarantee an optimum abrasion of the base at heavy fitted skis, the skis have to be ground partially with increased grinding force at the ski tip and ski end. For edge processing in the ski tip and ski end area a diminished grinding force will be an advantage.

i Adjusting the variable grinding force is the same procedure for all units. Following example describes the variable grinding force adjustment for the stone pre-grinding ski.

- eg.: open window "Stone parameters"

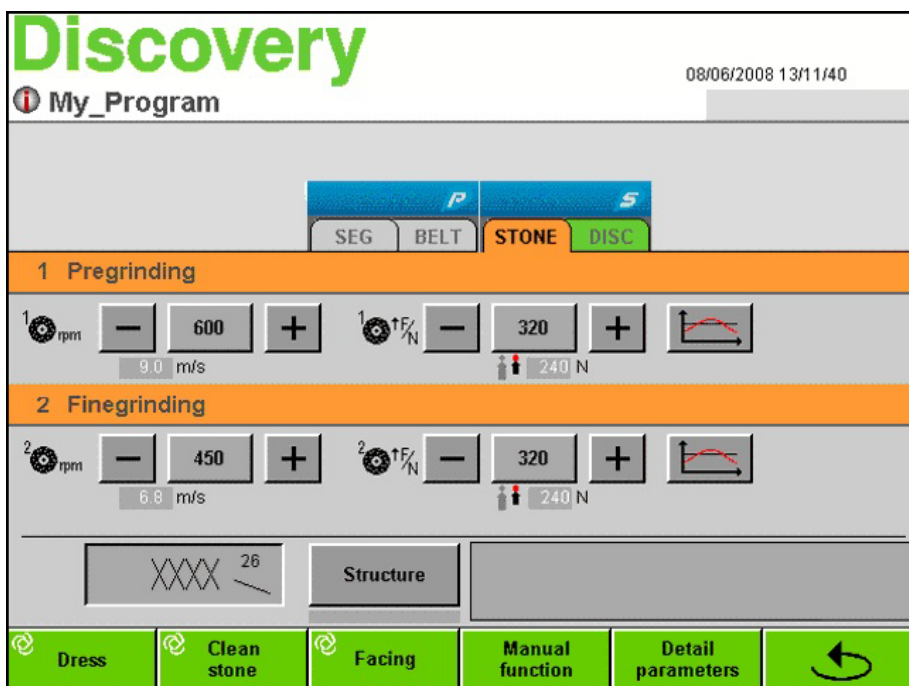

- Open the respective Servo menu by actuating the key "".

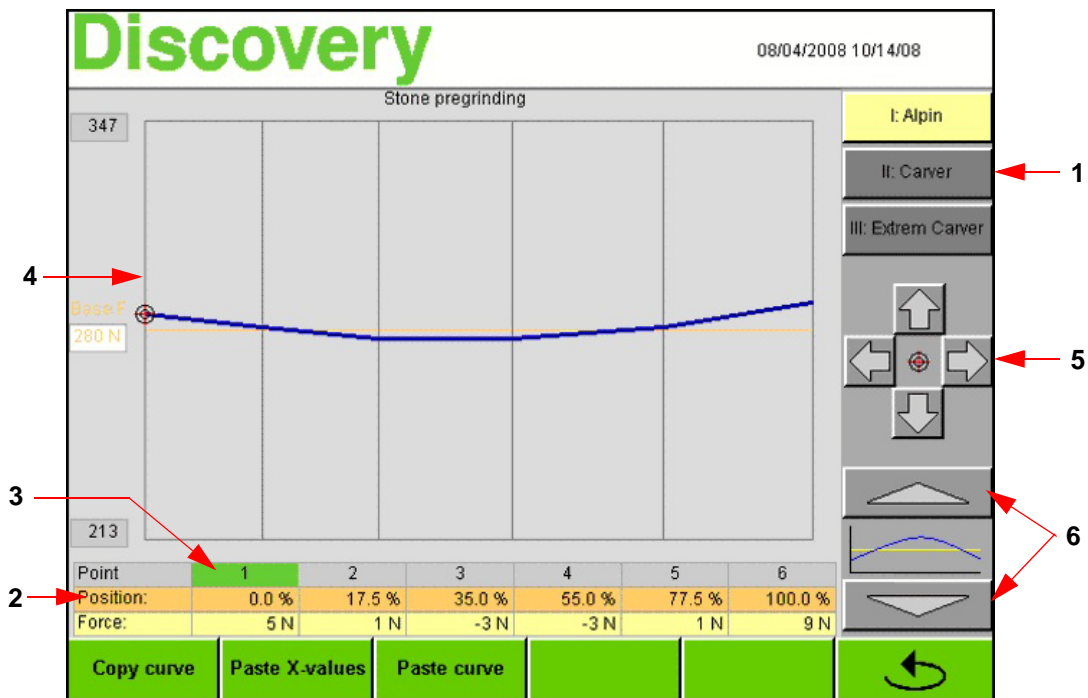

11.1 Changing the grinding force parameters

The grinding force and its areas can be set over the whole ski/board length. 3 pressure curves can be adjusted for every working process (eg. stone pre-grinding). These 3 pressure curves can be adapted according to ski or snowboard type.

- Actuate the respective key [1] to set the pressure curve for alpine skis, carving skis or extreme carving skis.
- 6 points [6] are set over the whole ski/board length. The ski/board length is shown in percentage (0% = ski end, 100% = ski tip).
- By actuating one of the keys 1, 2, 3, 4, 5 or 6, its color turns to green and the position in the curve is marked [4].
- The selected set point can be changed (starting with the preset base force) by the cursor keys [5].
- The horizontal position of the selected set point can also be changed by actuating the cursor keys [5].
- The position of the whole curve (starting with the preset base force) can be changed by actuating the keys [6].

11.1.1 Copy - paste curve

- The whole curve can be copied to another working process (eg. SE pre-grinding) by actuating the key "Copy curve".
- Additionally the positions [2] can be pasted in another working process (without copying the grinding force) by actuating the key "Paste X values".

12 General adjustment



- Following screen is opened by actuating the key "Menu".

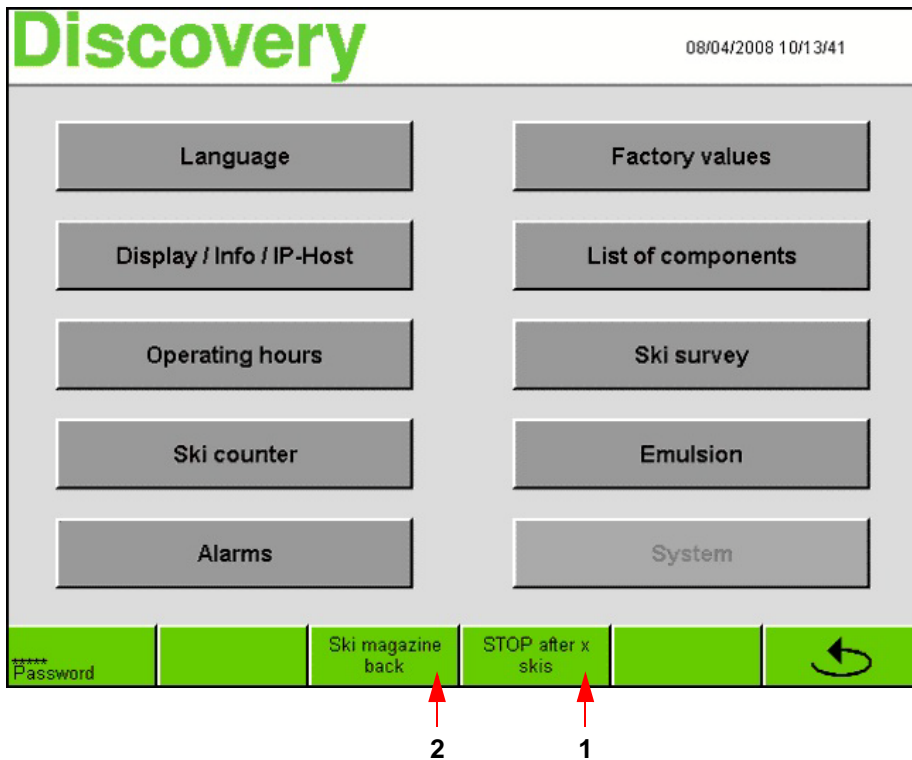

12.1 Stop after x skis

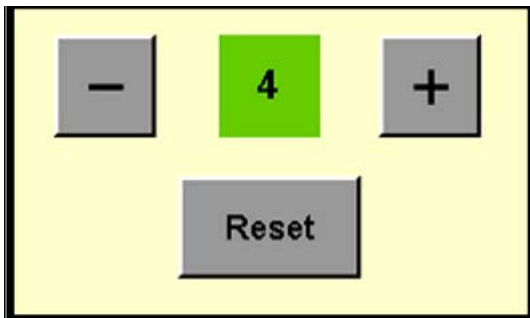

- An additional window is opened after pressing the button [1] "STOP after x skis".
- By pressing the +/- buttons, the number of skis can be entered until the machine is stopped.
- The input is activated by pressing the "↶" button and you then return to the main screen.
- The input is deleted by pressing the "Reset" button and the function is finished.



The number of skis up until the machine is stopped is displayed on the "STOP" button in the main screen.

12.2 Ski magazine return

By pressing the button [1] "Ski Magazine Return", the ski magazine cycles back by one ski when charging.

12.3 Language selection

- The menu for selecting the language is opened by actuating the key "Language".



- The whole menu-driven application is set to the desired language by touching the respective language.
- By actuating the key "↶" this screen is left and the "Menu" is opened again.

12.4 Change date, time and display brightness

- Following window is opened by actuating the key "Display/Info".

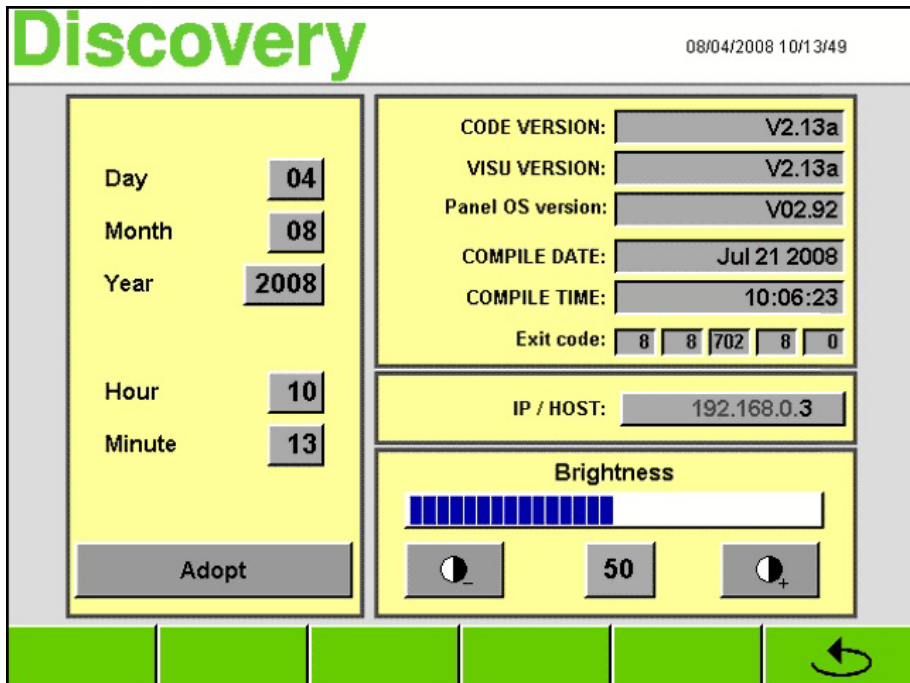

- Actuate the desired field.
- Enter the desired number via the number block and confirm with "ENTER".
- By actuating the key "Adopt" the adjustment is adopted to the system.
- Brightness of the display can be adjusted by actuating the respective keys +/-.
- By actuating the key "↻" this screen is left and the "Menu" is opened again.

12.5 Operating hours

- Following window is opened by actuating the key "Operating hours".

Discovery
08/04/2008 10/13/53

<p>FEED FRONT</p> <p>Main motor <input type="text" value="20 : 13 : 57"/></p> <p>Way [m] <input type="text" value="15804.0"/></p> <p>Motions <input type="text" value="4821"/></p>	<p>PUMP</p> <p>Water pump 1 <input type="text" value="673 : 11 : 32"/></p> <p>Water pump 2 <input type="text" value="672 : 55 : 35"/></p> <p>Drain water pump <input type="text" value="135 : 01 : 06"/></p>
<p>FEED BACK</p> <p>Main motor <input type="text" value="387 : 58 : 45"/></p> <p>Way [m] <input type="text" value="272993.8"/></p> <p>Motions <input type="text" value="49161"/></p>	<p>FAN</p> <p>Drying fan <input type="text" value="619 : 18 : 52"/></p>
<p>Ski counter</p> <p>SKI <input type="text" value="2155"/></p> <p>BOARD <input type="text" value="28"/></p> <p>EXTRA <input type="text" value="0"/></p>	

BELT
STONE 1
FINISH

↶

- All operating hours of the feed system, the pumps and fans are shown in this window. The operating hours of the available modules can be viewed by actuating the respective button "BELT", "STONE1" or "FINISH".

12.6 Ski/board counter

- Following window is opened by actuating the key "Ski counter".

	SKI	BOARD	EXTRA	Reset since:	Reset
Total	2155	28	0		
#1	2004	28	0	153 d 1 h	Reset
#2	1806	28	0	139 d 0 h	Reset
#3	1806	28	0	139 d 0 h	Reset
#4	1806	28	0	139 d 0 h	Reset
#5	61	0	0	53 d 15 h	Reset

Total counter

- First line shows the total numbers of ground skis, boards or extras since first start up of the machine.

Daily counter

- 5 daily counters can be managed for skis, boards or extras.
eg. by actuating the key "RESET" in line "#1", the counter, date and time of counter 1 are reset to "0".
- By actuating the key "↶" this screen is left and the "Menu" is opened again.

12.7 Alarm history

- Actuate key „Alarms“ in the screen MENU.

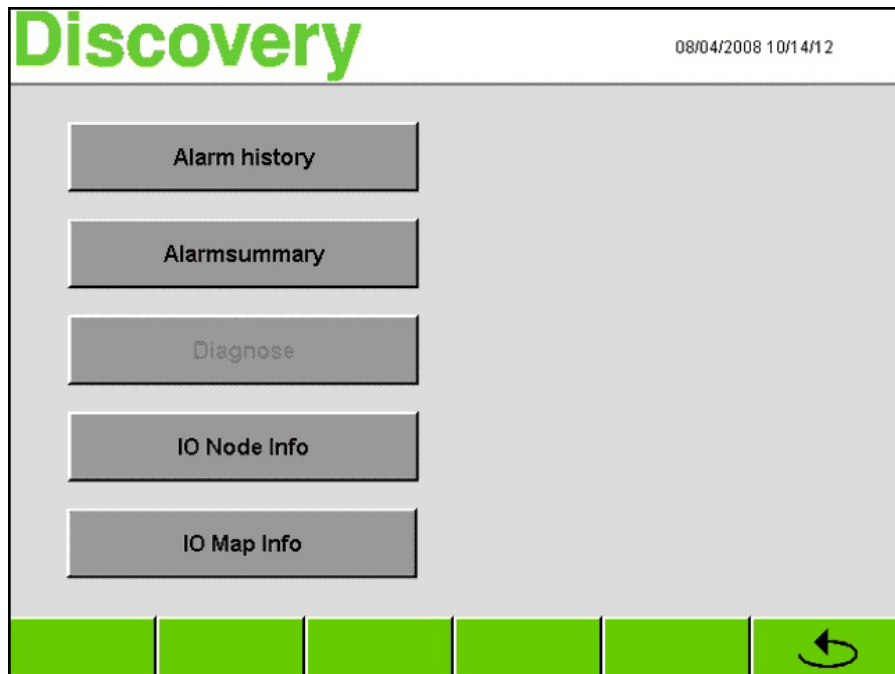

- Following screen is opened by actuating the key "Alarm history".

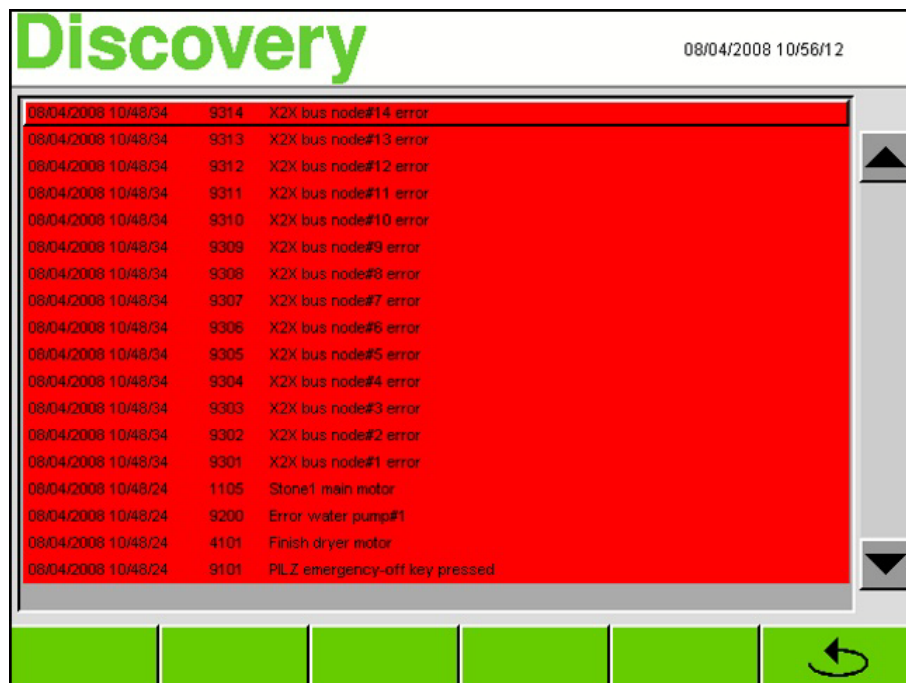

- This window shows all error messages since first start up of the machine.
- This message list can only be deleted by a WINTERSTEIGER Service Technician.
- By actuating the key "  " this screen is left and the "Menu" is opened again.

12.8 Factory values

- Following screen is opened by actuating the key "Factory values".

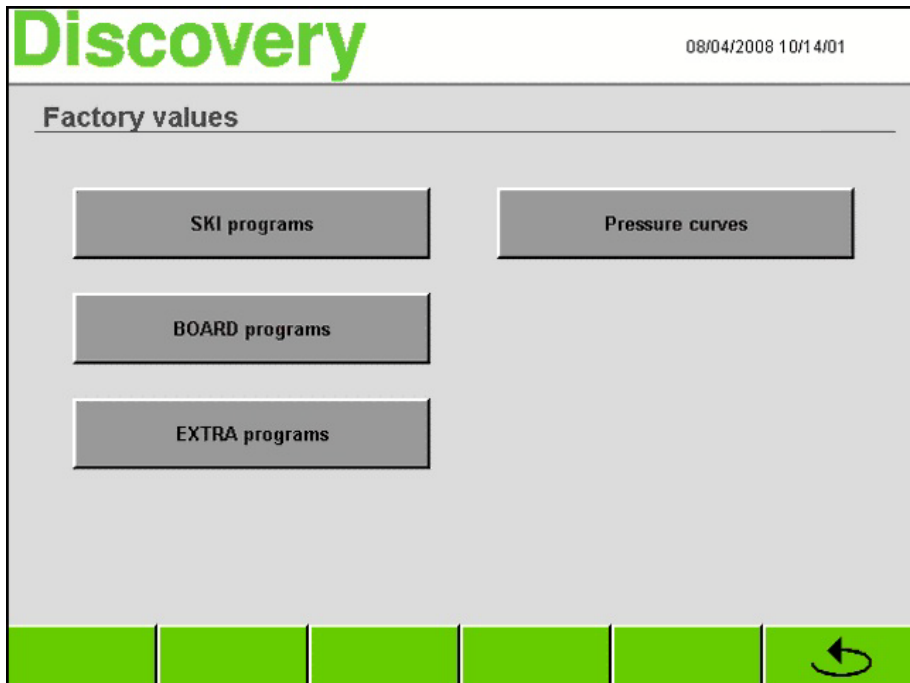

- The original WINTERSTEIGER programs for SKI, BOARD, EXTRA can be generated in this window.



This is necessary, e.g. for module extensions or with a software update!

Pressure curve

- All pressure curves are reset to the preset WINTERSTEIGER values by actuating this key.
- By actuating the key "" this screen is left and the "Menu" is opened again.

12.9 List of components

- Following window is opened by actuating the key "List of components".

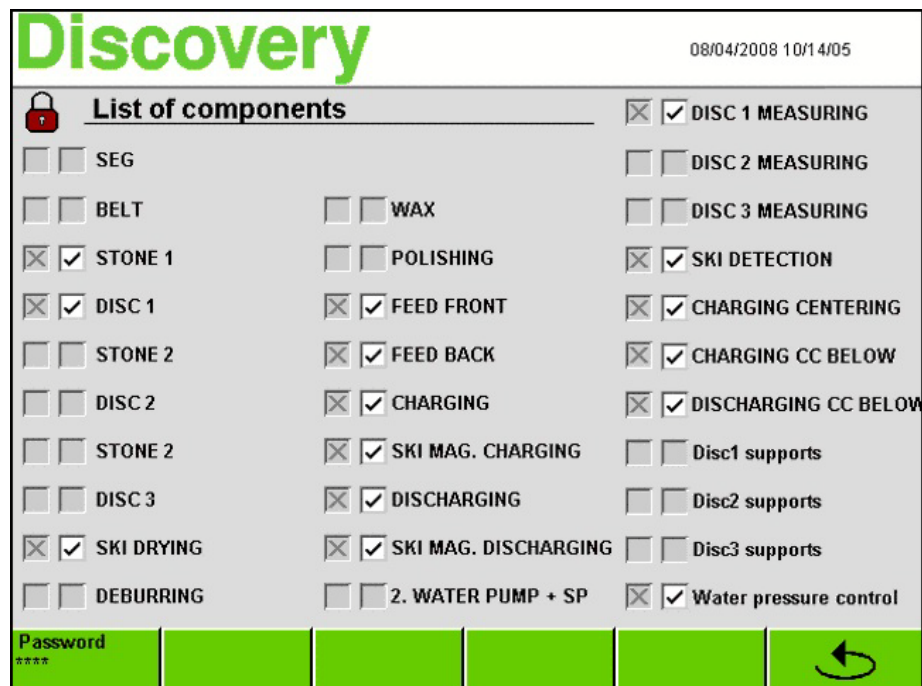

- All available components are marked with [X].
- In case of a failure, the respective unit can be deactivated.
- To avoid accidental deactivation of a component, a password has to be entered first.

12.9.1 Password for component list

- By actuating the key "Password" a number block opens
- Enter password: 7752
- After entering the password the lock on the top left is shown green.
- Now the respective component can be deactivated.



A manually deactivated component is activated automatically with the next start-up of the machine (by actuating the main switch).

- By actuating the key " " this screen is left and the "Menu" is opened again.

12.10 Ski measurements

- The following window will be opened by pressing the "Ski measurements" button in the "Menu" window.

The automatic ski model recognition is displayed in this window and is predominantly used by the WINTERSTEIGER service engineers for fault analysis.

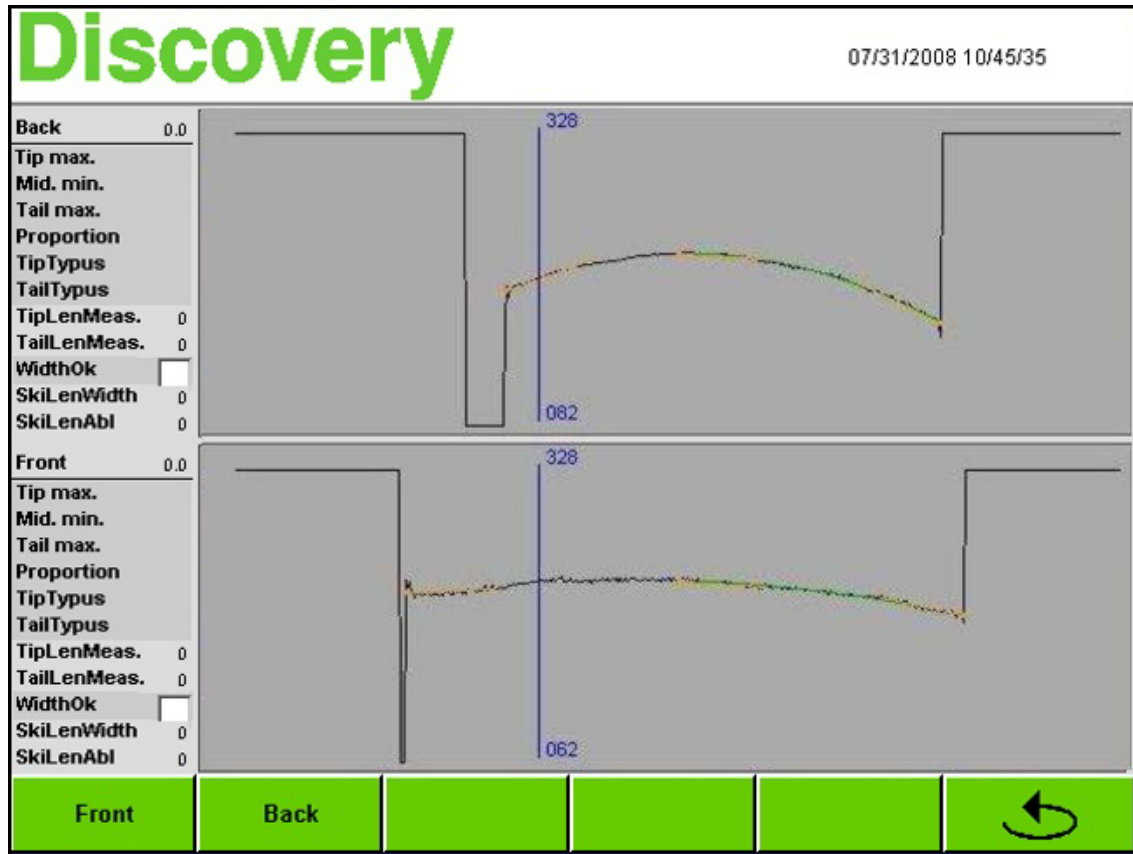

- Press the "" button to open the main screen.

12.11 Emulsion calculator

- The following window is opened by pressing the "Emulsion" button in the "Menu" window.

The emulsion calculator is used to calculate the correct mixing ratio for the emulsion.

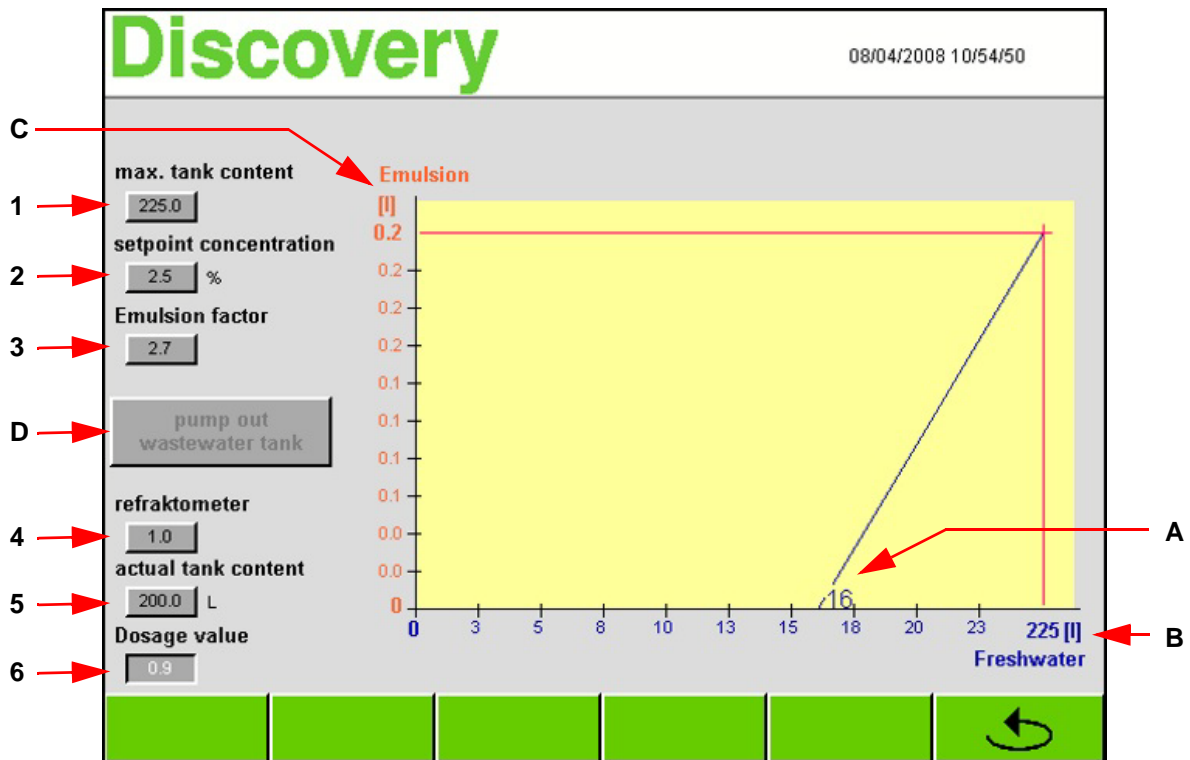

i Before the mixing ratio and the tank content can be measured, the machine has to be previously switched off for at least 15 minutes to allow the residual water to drain into the tank to be able to obtain correct values using the emulsion calculator. Waste water tanks must be pumped empty by pressing the [D] button before the measurement is carried out.

Max. tank content [1]

- The maximum filling amount of the water tank is specified in this input field. The filling quantity is 450 or 225 liters, depending on the machine type.

i The values for the 225 liter tank apply for the following description!

Setpoint concentration [2]

- The emulsion/water mixing ratio is specified in this input field. The required mixing ratio can be seen on the corresponding emulsion container.

Emulsion factor [3]

- The emulsion factor for converting the actual mixing ratio using the value read with the refractometer is specified in this input field.

The required emulsion factor can be seen on the corresponding emulsion container or in the operating manual of the refractometer.

Sample calculation

- The measured value of the refrigerant on the refractometer is 1.0 and the filling amount is approx. 400 (200) liters depending on the machine type.
- Enter the value 1.0 in the "Refractometer value" input field [4].
- Enter 400 (200) liters in the "Actual tank content" input field [5].

The following data can be seen in the emulsion diagram according to the example:

- A: The optimum emulsion/water mixing ratio is provided again if the tank is topped off with 32 (16) liters of fresh water.
- B: The water tank is full again if the tank is topped off with 50 (25) liters of fresh water.
- C: If the tank is topped off with 50 (25) liters of fresh water, 0.4 (0.2) liters of emulsion must be added.

Dosage value [6]

If an emulsion mixing device with a dosing unit (order number 55-645-311) is available, set the displayed dosage value to 50 (25) liters of fresh water.

12.12 Automatic filling of the cooling lubricant tank (optional)

The automatic filling functions are only available in conjunction with automatic water filling (order No. 8550-1451-V01).

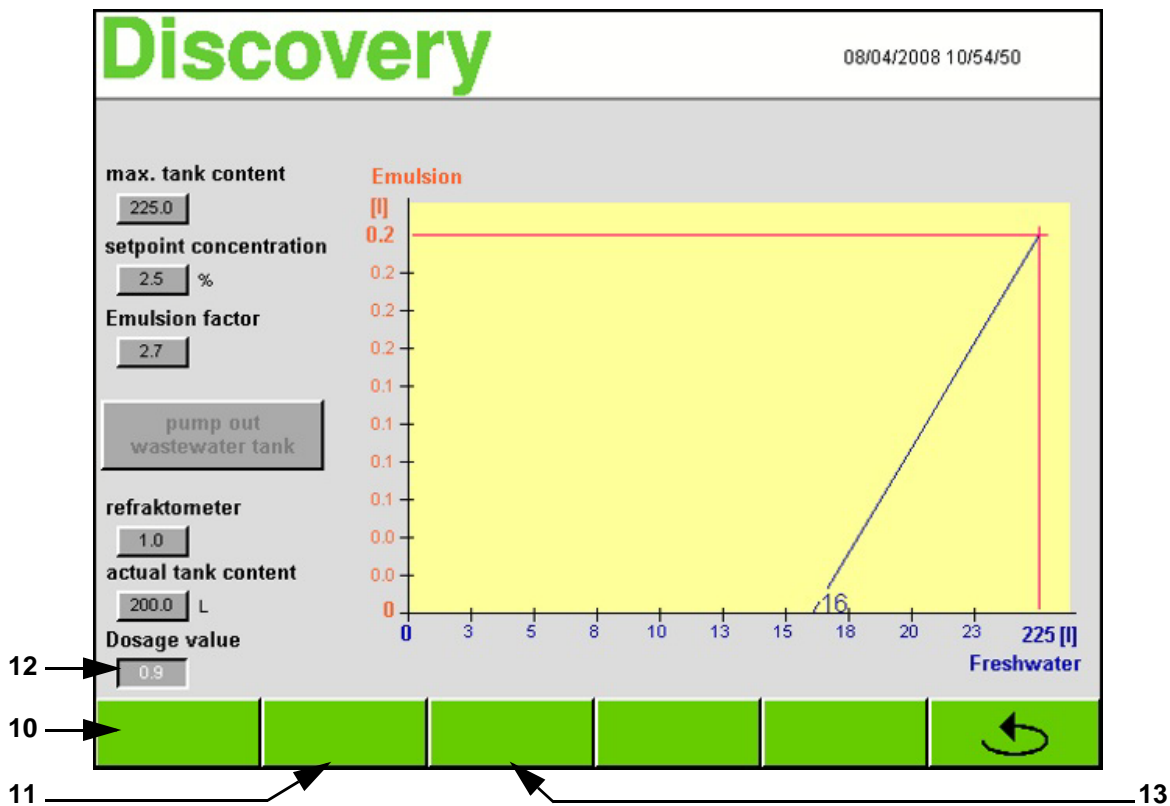

Partial filling [10]

- Pressing the "Partial filling" button will cause the cooling lubricant tank to be filled to a preset level.

If, for example, the error message "Cooling lubricant below minimum level, please fill!" is displayed, it can be partially filled during operation.

However, the cooling lubricant tank must be filled completely as soon as grinding work on the machine has been completed.

Max. filling [11]

Prior to automatic maximum filling of the cooling lubricant tank, the mixing ratio must be determined using the emulsion calculator ([see chapt. 12.11 Emulsion calculator, page 84](#)).

If an emulsion mixing device with a dosing unit (order No. 7019-1011-V02) is available, the dosage value [12] must be set. For automatic water filling, the calculated amount of emulsion must be filled into the cooling lubricant tank prior to filling.

Stop filling [13]

If the "Stop filling" button is pressed, automatic filling is immediately stopped.

13 Overview adjustment parameters



The following tables show the most important adjustment parameters with their adjustment areas and set values.

13.1 Adjustment parameters module PREGRIND

	Parameters	Adjustment area min. - max	Standard set value	Working range < set values	Working range > set values
Module PREGRIND					
SEG	Force	5-149 N	35-45 N	< 35 less cutting	> 45 danger of damage to edge due to heat
	Initial point	-100-50mm	0		
	Oscillation	max/min/OFF	max	min or OFF for grinding children skis	
BELT	Force	100-400 N	150-200 N		
	Grinding speed	500-1700 rpm	950 rpm		
	Initial point	-100-50mm	0		
	Oscillation	ON/OFF	ON		

13.2 Adjustment parameters module STONE

	Parameters	Adjustment area min. - max	Standard set value	Working range < set values	Working range > set values
Stone unit					
Stone pre-grinding	Stone processing	1-13	2-6	< 2 only for structuring	> 4 for extreme damages
	Pre-grinding rpm	150-2000 rpm	500-700 rpm	< 500 rpm less cutting	> 700 rpm danger of damage to base due to heat
	Pressure stone	50-500 N	260-320 N	< 260 N less cutting	> 320 N danger of damage by the stone
	Structure	Linear structure Cross structure Diagonal cross structure right Diagonal cross structure left Arrow structure V-structure Wave structure	Linear structure Cross structure Diagonal cross structure right Diagonal cross structure left	Crossed and diagonal crossed structures have good rotary features - best for average skiers	Linear structure has good guiding features at high speed, but has an influence on the rotary features. So this structure should only be used for skilled skiers.
	Dressing speed	3-35 mm/sec.	16-20 mm/sec.	16 mm/sec. for dry snow	20 mm/sec. for wet snow
	Dressing rpm	600-2000 rpm	1000	< 1600 rpm too rough structure	
Stone fine-grinding	Stone processing	1-13	1		
	Fine-grinding rpm	150-2000 rpm	350-450 rpm	< 350 bigger structure distance	> 450 rpm deteriorates structure image
	Pressure stone	50-500 N	280-340 N	< 280 N less cutting	> 340 N danger of damage by the stone
	Structure	Linear structure Cross structure Diagonal cross structure right Diagonal cross structure left Arrow structure V-structure Wave structure	Linear structure Cross structure Diagonal cross structure right Diagonal cross structure left	Crossed and diagonal crossed structures have good rotary features - best for average skiers	Linear structure has good guiding features at high speed, but has an influence on the rotary features. So this structure should only be used for skilled skiers.
	Dressing speed	3-35 mm/sec.	16-20 mm/sec.	16 mm/sec. for dry snow	20 mm/sec. for wet snow
	Dressing rpm	600-2000 rpm	1600-2000 rpm	< 1600 rpm too rough structure	
Disc unit					

	Parameters	Adjustment area min. - max	Standard set value	Working range < set values	Working range > set values
SE grinding	SE processing	1-13	1-2	1 process for slightly damaged skis 2 processes for normal damage and 3 processes for extreme damage	
	Pre-grinding rpm	1500-4500 rpm	3800-4000 rpm	<3800 rpm less cutting	> 4000 rpm deteriorates grinding image
	Fine-grinding rpm	1500-4500 rpm	3000 rpm		
	Pressure SE	5-75 N	50-75 N	< 50 N less cutting	
	Initial point SE	-100-50mm	0	Use for rental skis to vary the initial point of the SE processing.	
BE grinding	BE processing	1-13	1	only 1 grinding process necessary	
	Pre-grinding rpm	1500-4500 rpm	3800-4000 rpm	<3800 rpm less cutting	> 4000 rpm deteriorates grinding image
	Fine-grinding rpm	1500-4500 rpm	3000 rpm		
	Pressure BE	5-65 Nm	40-50 N	< 40 N structure in edge	> 50 N grinding on the base
	Initial point BE	-100-50mm	0	Use for rental skis to vary the initial point of the SE processing. This function can also be used for carving skis if necessary.	

14 Maintenance - service

14.1 General

14.1.1 Cleaning the inside of the machine



To prevent corrosion, always use the cleaning pipe and coolant when cleaning the machine!

The following points must be observed when cleaning the unit with the doors open:

- Main switch must be switched on
- Press stop key
- After approx. 15 seconds respectively after announcement on the display the sliding door can be opened.
- Start window is displayed on the screen



- Close the central stop valve ([see chapt. 6.4 Operating elements module STONE, page 25](#))
- Press key [1] to activate the cleaning pump.
- Switch off cleaning pump by actuating key [2].
- If the stationary grinding stone is sprayed over with the cleaning hose when the machine is cleaned, the grinding stone should be spin-dried by pressing the button [3] (risk of unbalance).



Close the doors beforehand!

14.1.2 Maintenance base machine - coolant tank - charging/discharging

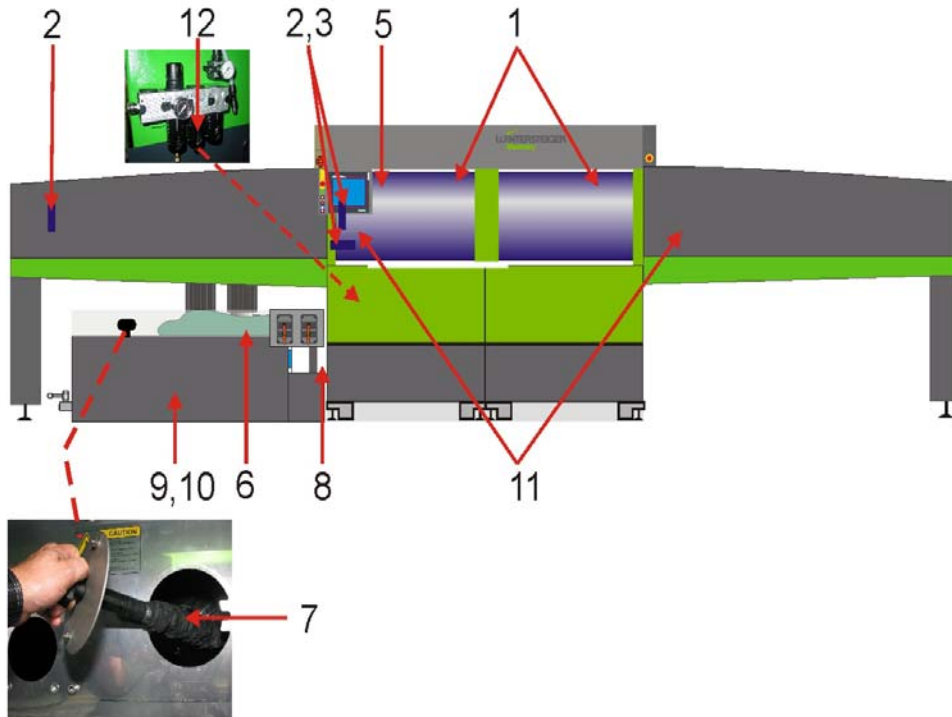

Pos. no.	Maintenance works	daily	weekly	every 2 nd week	monthly	annually	Comments
Cleaning							
1)*	Whole machine outside and inside	x					Clean sealing lips before closing and mounting covers
2)	Photoelectric barriers	x					
3)	Laser		x				
4)	Support rollers and centering rollers		x				
5)	Surface Touch Display	x					When the machine is switched off - with a damp cloth - do not use cleaning agent
Coolant system							
6)	Check filter bag and clean it, if necessary	x					more often if necessary
7)	Clean the bar magnet	x					Remove the bar magnet from the cooling agent container and clean using a cloth (carry out frequently when required).

Pos. no.	Maintenance works	daily	weekly	every 2 nd week	monthly	annually	Comments
8)	Check coolant level		x				more often if necessary
9)	Check pH-value and mixing ratio		x				suitable measuring instrument available
10)	Change coolant				x		see chapt. General indications for proper dealing with lubricating coolant Mixing ratio: see indications of tank
Miscellaneous							
11)	Check function of safety flaps			x			Remove ski magazines (see chapt. 6.2 Operating elements ski magazine, page 21) Actuate safety flap with an object (e.g. ski) when the machine is switched on. Machine must automatically switch to emergency-stop!
12)	Check compressor tank and maintenance unit for condensation; empty if necessary		x				
13)	Service by WINTERSTEIGER Customer Service					x	Wear and tear cannot be avoided! Expert maintenance and inspection prevents and protects against failures and consequential damages!

* Danger of corrosion: Do not use tap water for cleaning the machine! Use cleaning hose and coolant only!
Do not clean the machine with a high-pressure cleaner! In the event that this instruction is not adhered, WINTERSTEIGER will refuse any liability and guarantee for any damage caused.

14.1.3 Emergency release of the sliding doors



Opening with the emergency release is exclusively allowed when the voltage drops (if necessary) or when the door switch is defective.

- Open the bottom cover [A] of the respective sliding door.
- Remove screw [B] with TORX screwdriver.
- By pressing the holder [C] Ø2.5mm (0.098 in) and pulling the sliding door it can be opened.

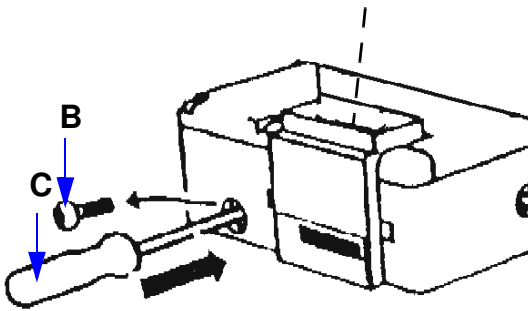

After opening the sliding door, screw the screw (B) into the safety tumbler.

14.1.4 Clean laser

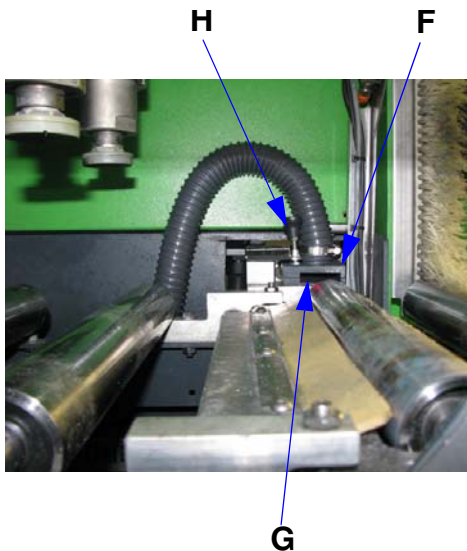

The laser must be cleaned once a week to guarantee correct ski measurements!



Do not spray the laser with the cleaning pipe!

- Switch the machine to cleaning mode ([see chapt. 14.1.1 Cleaning the inside of the machine, page 91](#))
- Remove ski magazine of charging ([see chapt. 6.2 Operating elements ski magazine, page 21](#))



Risk of eye injuries!

Attention - do not look into the laser!

- Strip the fastening screw of the laser cover.
- Remove laser cover [F] by lifting it.

- Clean the laser glass [G] with a soft cloth and window agent.
- Put on the laser cover [F] again - considering the position holes!
- Tighten the fastening screw.

14.1.5 Battery change on the operating panel

The battery must be changed within one week, if the information "Battery empty" is shown in the message line on the operating terminal.

The operating life of the battery is approx. 5 years under normal conditions, reduced however by higher temperatures.



Always have a new battery ready!

If the battery is not changed in time, the complete adjustment values could be deleted.

Battery change as follows:

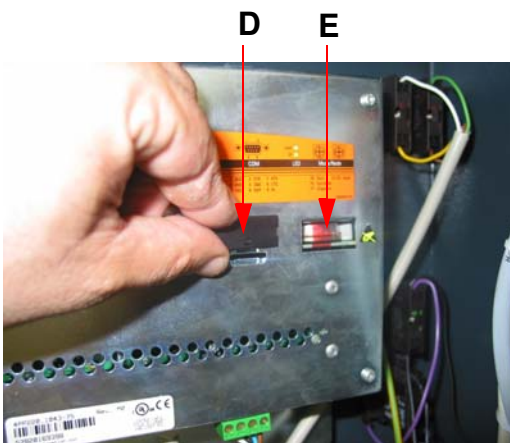

- Switch off main switch.
- If the service voltage was not switched on yet, switch it on for one minute at least and then off again.
- Open the rear cover of the operating panel by removing 2 screws.
- Remove battery cover [D].
- Remove battery [E] and plug-in new battery immediately (part no. 15-480-106)



The battery change must be done within 5 minutes to avoid an overrun of data on the SPS-control.

Do not touch the battery with pliers or bare tweezers --> Short circuit! Only touch the battery at the ends.



Lithium batteries have to be disposed as hazardous waste! Used batteries must therefore be disposed of accordingly.

14.1.6 General indications for proper dealing with lubricating coolant

To comply with its job of lubricating coolant (cooling, lubrication, removal of cutting, corrosion protection) lubricating coolant includes a lot of different chemical substances. So the corresponding maintenance and care of the lubricating coolant is very important.

Organizational steps



Please pay special attention to having clean coolant to avoid formation of nitrosamines and germs!

Please note following indications:

- Introduction of inorganic and organic food, remains of cigarettes, anticorrosive-agent cleaner, etc.
- Avoid admission of oil impurities to cooling system
- Avoid introduction of foreign substance which contains secondary amines or release them (more than 0.2 % in the cooling lubricant concentrate) e.g. cleanser, certain anticorrosive agent, system cleanser.

Following inspections and measurements have to be carried out. In Austria and Germany the TRGS 611 form the legal grounds for the limiting value. Other countries the limiting values have to be respected according customary laws.

Inspection	Measuring interval	Limiting value
KSS-Concentration	weekly	see indication of manufacturer
Nitrate level deposit water	from time to time	max. 50 mg/l
pH-factor	weekly	8.5 - 9.0
Nitrite	weekly	max. 20 mg/l
Germination index (recommended)	monthly	10 ⁶ germs
Total hardness	if required	ca. 16°d

Within the scope of FLUID MANAGEMENT WINTERSTEIGER offers analysis equipment for control and measurement of lubricating coolant as well as documentation of the test results. When overranging the limiting values you are able to place countermeasures immediately to extend the intervals for changing the coolant by 4 weeks essentially. WINTERSTEIGER-fluid management also includes additional products (high quality lubricating spray, system cleanser, machine foam cleanser, preservative agent, skin protection set) which are coordinated with the emulsion and so avoid an introduction of foreign substance to a great extent.

When overranging the limiting values please place corresponding countermeasures or change the coolant. As a result of non-application of WINTERSTEIGER-fluid management the emulsion has to be changed after approx. 1000 pair of ski or at the latest after 4 weeks. After the season and a longer standstill of the machine drain the cooling system and clean it with the system cleanser.

Protective measures

As lubricating coolants are, among other things, irritants, we recommend wearing corresponding protective clothing (e.g. gloves, safety goggles, fluid-repellent clothes). If you were not able to avoid contact with skin please use preventive skin protection (barrier cream).

Disposal

Take care that nothing gets into the sewage system. Duly, dispose according to the indications of the manufacturer in the general safety and prevailing regulations is essential.

14.2 Maintenance - service module PREGRIND

14.2.1 Changing the grinding belt SEG

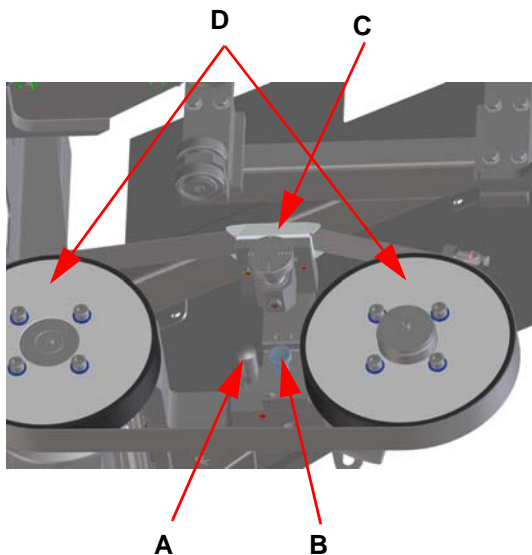

i SEG has to be in changing position before changing the belt ([see chapt. 10.4.1.2 Manual functions SEG, page 50](#))!

- Press stop key.
The sliding door can be opened after approx. 15 seconds.
- Switch off main switch.
- Cut off compressed air ([see chapt. 5.1.1.1 Cut off compressed air, page 18](#)).
- Push belt tensioner [A] in the direction of grinding block.
- The bolt [B] must click into place.
- Remove old grinding belt and push the new belt flush over the contact wheels [D].

i **Observe the rotation direction!**
On the inside of the grinding belt are direction signs which have to match to rotation direction!
Check contact wheels [D] for debris and make sure the wheels are clean before installing the new belt. This will insure better grinding results.

- Apply tension to the new belt by actuating the belt tensioner [A].
- Open compressed air supply on the stop valve again after closing all covers.

14.2.2 Dressing the SEG belt

! For optimum performance of a new grinding belt, it must be softened (dressed) prior to use to prevent damage to the ski. Diamond abrasive belts must not be dressed!

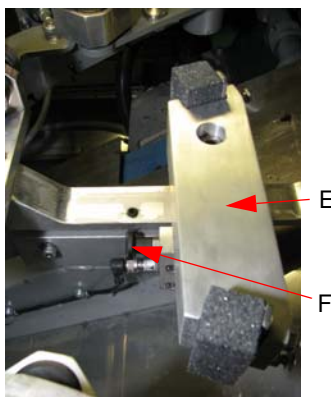

- Press the stop button.
- The sliding door of the pre-grinding module can be opened after 15 seconds.
- Insert belt dressing fixture [E] into the opening provided and secure it with locking pin [F].
- Close the sliding door and start the machine.
- By pressing the "Dress belt" button in the "Manual functions SEG" window the two grinding belts will be softened with the pre-set time.

! After belt dressing the belt dressing fixture must be removed again!

14.2.3 Changing the grinding belt of belt unit

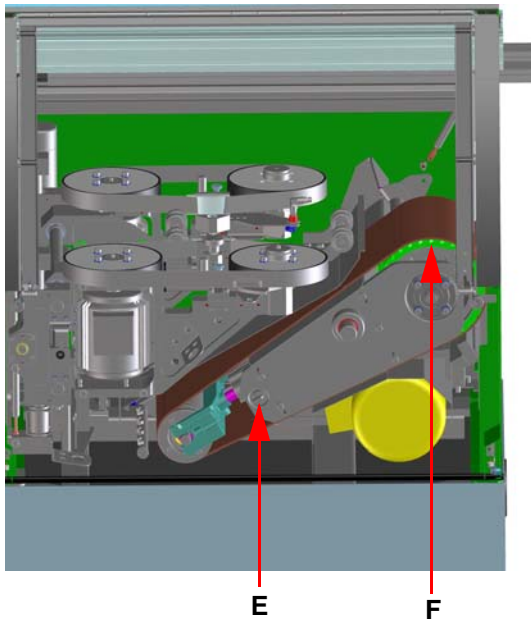

i Belt unit has to be in changing position before changing the belt ([see chapt. 10.4.1.2 Manual functions SEG, page 50](#))

- Press stop key.
The sliding door can be opened after approx. 15 seconds.
- Switch off main switch.
- Loosen the belt by pressing the switch [E].
- Remove old grinding belt.
- Push the new belt flush over contact wheel and deflection roller.

i Observe the rotation direction!

On the inside of the grinding belt are direction signs which have to match to rotation direction!
Check contact wheel [F] for debris and make sure the wheel is clean before installing the new belt. This will insure better grinding results.

- Apply tension to the new belt by actuating the switch [E].

i New grinding belts have to be dressed before use to avoid damaging the ski base and to guarantee an optimum application. ([see chapt. 10.4.2.2 Manual functions belt unit, page 53](#)).

14.2.4 Maintenance works

Pos. no.	Maintenance works	daily	weekly	every 2 nd week	monthly	annually	Comments
Cleaning							
1)*	Whole module outside and inside	x					Clean sealing lips before closing and mounting covers
Lubrication							
2)	Lubricate guides of SEG		x				1 press stroke with grease per lubricator nipple
3)	Lubricate flange bearing of belt unit					x	1 press stroke with grease per lubricator nipple after season. Then turn on the machine again with closed central stop valves
4)	Check dressing stones for wear, change them if necessary				x		

* Danger of corrosion: Do not use tap water for cleaning the machine! Use cleaning hose and coolant only!
Do not clean the machine with a high-pressure cleaner! In the event that this instruction is not adhered, WINTERSTEIGER will refuse any liability and guarantee for any damage caused.

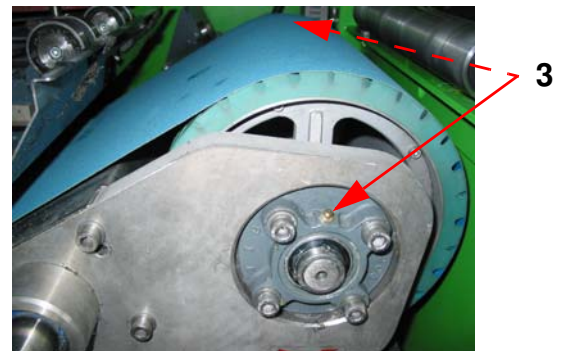
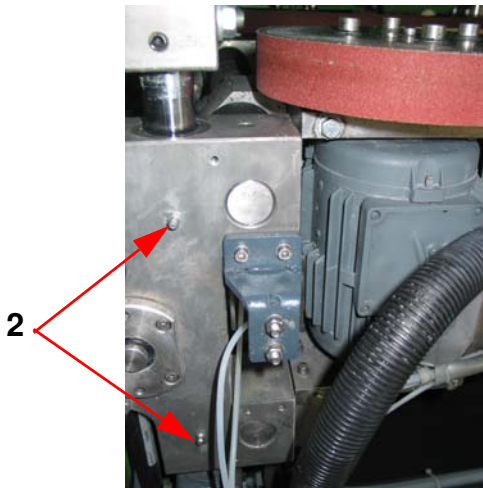

14.3 Maintenance - service module STONE

14.3.1 Changing the grinding stone

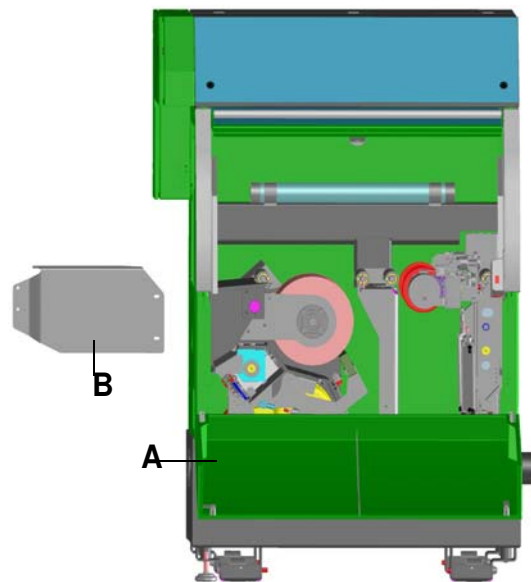

Stone unit has to be in changing position before changing the stone ([see chapt. 10.5.5 Manual functions stone unit, page 67](#))!

- Press stop key.
- The sliding door can be opened after approx. 15 seconds.
- Switch off main switch.
- Cut off compressed air ([see chapt. 5.1.1.1 Cut off compressed air, page 18](#)).
- Open bottom cover [A] and demount cover [B] before removing the stone.
- Loosen 2 headless pins [C] on the flange bearing.
- Remove two dowel screws [D] on the stone support [E]. If necessary, loosen the threaded bolt of the stone support [I] by screwing in hexagon socket screws.
- Detach the stone support [E].
- Hold with key (SW24) on shaft and loosen nut [F] with key (SW55).
- Pull off grinding stone.

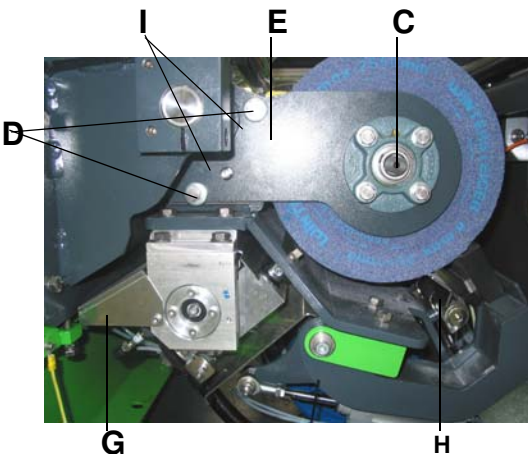

Clean and lubricate drive spindle!

- Turn back the distance sheet for the stone spraying completely.
- Turn back the diamond completely with ratched wheel [G].
- Place new grinding stone onto drive spindle.



Be sure to check new grinding stone for damage from transport.

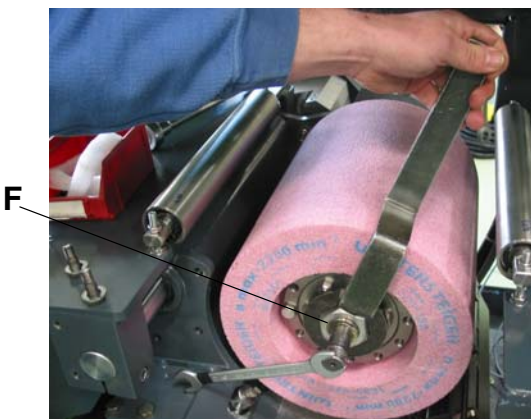

- Screw on nut [F] at grinding stone.
- Mount stone support [E] with 2 dowel screws [D].
- Tighten the 2 headless pins [C] at flange bearing.
- Set the distance from the distance sheet for the stone spraying [H] to the stone to 1-3 mm.



Adjust the diamond as described in [chapt. Changing the diamond!](#)

- Mount cover [B] again and close bottom cover [A].
- Open compressed air supply on the maintenance unit again after closing all covers.
- Carry out test run ([see chapt. 14.3.4 Carry out test run according to official regulations, page 102](#)).



After the grinding stone has been replaced, check and if necessary, correct the stone diameter! ([see chapt. 10.5.6 Check and adapt stone diameter, page 68](#)).

14.3.2 Changing the diamond

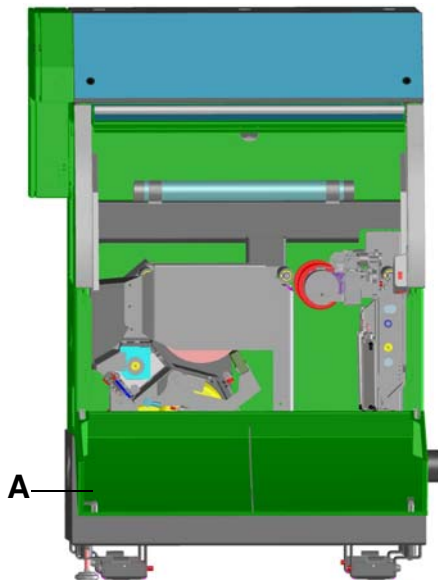

Diamond has to be in changing position before changing it ([see chapt. 10.5.5 Manual functions stone unit, page 67](#))!

- Press stop key.
- The sliding door can be opened after approx. 15 seconds.
- Switch off main switch.
- Cut off compressed air ([see chapt. 5.1.1.1 Cut off compressed air, page 18](#)).
- Open bottom cover [A].
- If necessary, turn the dresser block [B] completely to the outside by a hexagon socket key SW4 [C].
- Loosen hexagon socket screw [D], remove dressing diamond and clean borehole. Install and tighten new diamond with well lubricated shaft up to the limit stop.



Screw must be pressed against end face of diamond shaft.



C

D

- Turn back dressing diamond with ratchet wheel [E] (distance stone to diamond approx. 2 mm, 0.08 in).
- Turn in dressing carriage [B] with hexagon socket key SW4 [C] up to the position where the diamond projects over the grinding stone.
- Turn the stone slowly by hand.
- Turn the diamond with the ratchet wheel [E] until there is a contact on the stone.
- Close bottom cover [A] and sliding door.
- Switch on main switch - press start key.

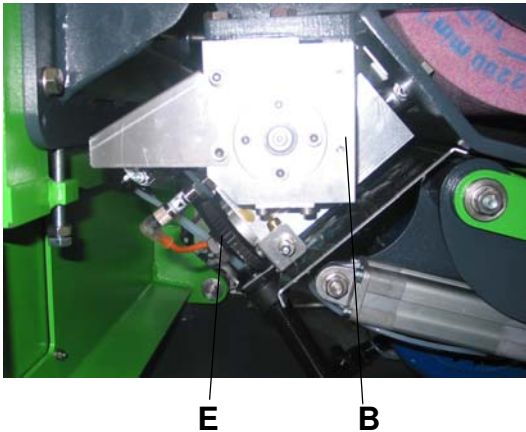

- Actuate key "DRESS" until the stone runs smoothly (at least 5x).



After changing the diamond check the diameter of the grinding stone and correct it, if necessary ([see chapt. 10.5.6 Check and adapt stone diameter, page 68](#))!

- Open compressed air supply on the maintenance unit again after closing all covers.

14.3.3 Changing the ceramic discs

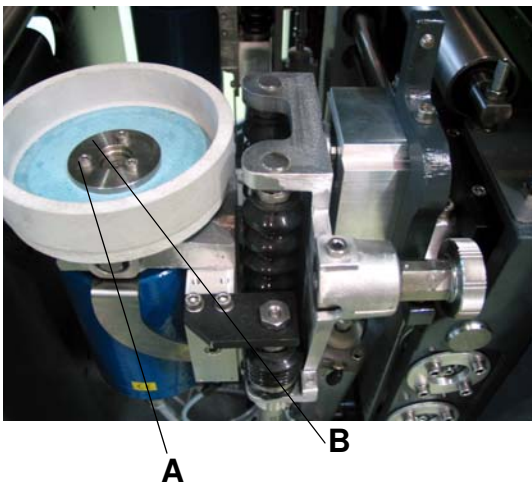

Before changing the ceramic discs, move the unit to the changing position ([see chapt. 10.6.2 Manual functions disc unit, page 73](#))!

- Press Emergency Stop key.
- The sliding door can be opened after approx. 15 seconds.
- Switch off main switch.
- Cut off compressed air ([see chapt. 5.1.1.1 Cut off compressed air, page 18](#)).
- Remove 3 hexagon socket head screws [A].
- Remove the ceramic disc.
- Clean flange and grease it with water-insoluble grease!
- Attach new ceramic disc (check new ceramic disc for damages from transport).
- Fit flange [B] and fix ceramic disc with hexagon socket head screws [A].
- Open compressed air supply on the maintenance unit again after closing all covers.
- Carry out test run ([see chapt. 14.3.4 Carry out test run according to official regulations, page 102](#)).

14.3.4 Carry out test run according to official regulations



A test must be performed for every grinding device with an outer diameter of more than 100 mm (3.94 in) before being used for the first time and after every retightening.

This test shall be conducted with no load, at the highest allowable peripheral speed and in the presence of

an expert. All grinding machines must be run for at least one minute. The test run may be performed only after all protective devices have been mounted and no one is standing in the danger zone. The grinding device may be used only after a flawless test run.

14.3.5 Maintenance works

Pos. no.	Maintenance works	daily	weekly	every 2 nd week	monthly	annually	Comments
Cleaning							
1)*	Whole module(s) outside and inside	x					Clean sealing lips before closing and mounting covers
Lubrication							
2)	Grease guides disc unit		x				1 press stroke with grease per lubricator nipple
3)	Grease flange bearings of stone unit					x	1 press stroke with grease per lubricator nipple after season. Then turn on the machine again with closed central stop valves
4)	Grease guides of dressing device		x				1 press stroke with grease per lubricator nipple
5)	Check the distance between the distance sheet of the stone spraying and the stone and adjust it, if needed; distance to the grinding stone about 1-3 m			x			clean if necessary

* Danger of corrosion: Do not use tap water for cleaning the machine! Use cleaning hose and coolant only! Do not clean the machine with a high-pressure cleaner! In the event that this instruction is not adhered, WINTERSTEIGER will refuse any liability and guarantee for any damage caused.

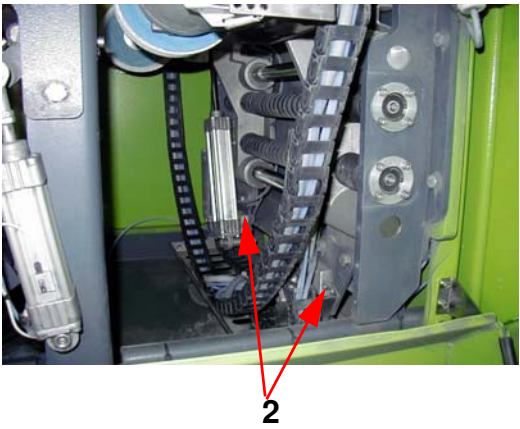
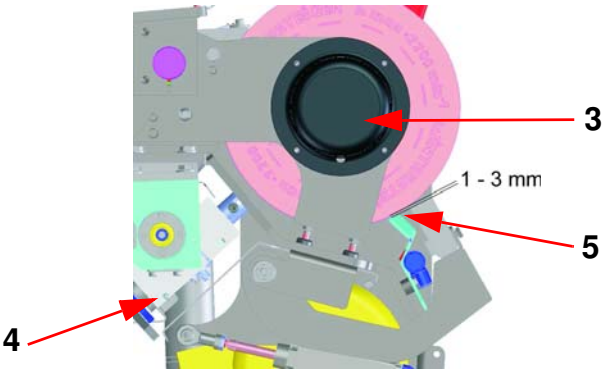

14.4 Maintenance schedule

Maintenance works	Month																																			
	1	2	3	4	5	6	7	8	9	10	11	12	13	14	15	16	17	18	19	20	21	22	23	24	25	26	27	28	29	30	31					
daily																																				
Clean whole machine outside and inside																																				
Check filter bag and clean it, if necessary																																				
Clean photoelectric barriers and laser																																				
Clean surface touch display																																				
weekly																																				
Lubricate guides of SEG																																				
Lubricate flange bearing of belt unit																																				
Lubricate guides of disc unit																																				
Check coolant level																																				
Check pH-value and mixing ratio																																				
Check wear of stone cleaning block																																				
Check wear of diamond																																				
Clean support and centering rollers																																				
Check compressor tank and maintenance unit for condensation; empty if necessary																																				
every 2nd week																																				
Check distance of spraying nozzles and adjust it, if necessary																																				
Check function of safety flap																																				
monthly																																				
Change coolant																																				
Check wear of dressing stone																																				
after season																																				
Service by WINTERSTEIGER Technical Service																																				
Lubricate flange bearing of stone unit with 1 press stroke with grease																																				
Lubricate flange bearing of belt unit with 1 press stroke with grease																																				
Change grease boxes just before season.																																				



Please copy before use!

15 Shut-down and disposal



WARNING Risk of injury!

Disconnect the machine from the mains supply or any external drive prior to shutting down and dismantling. Use only suitable tools for dismantling.



When shutting down the machine dismantle and dispose of all machine parts properly. Clean all oily and greasy components prior to disposal.

Oil and grease should never be allowed to pollute the environment.

Ensure that all disposal regulations specific to your country are adhered to!

- Dismantle the machine properly into its individual components.
- Clean oily and greasy components.
- Dispose of components by material group (steel, plastic, electrical and electronic components, etc.).
- Dispose of oil and grease in an environmentally friendly manner.

CE Konformitätserklärung
Declaration of Conformity
Certificat de conformité
Declaración de conformidad
Dichiarazione di conformità



Hiermit erklären wir, dass das Produkt:

We hereby declare that this product...

Par la présente nous certifions que le dit produit:

Por la presente declaramos que el producto:

Con la presente dichiariamo che il prodotto:

Discovery

No.:

S/SS/SSS/PS/PSS/PSF/PSSF/SF/SSF/SSSF

Steinschleifautomat/Automated Stone Grinder

folgender(-en) einschlägigen Bestimmung(en) entspricht

conforms to the following regulations:

correspond à la (aux) spécification(s) suivante(s)

corresponde a la(s) siguiente(s) directiva(s) competente(s)

è conforme alla(e) seguente(i) disposizione(i)

EG-Maschinenrichtlinie 2006/42/EG

EG-EMV-Richtlinie 2004/108/EG

EG-Niederspannungsrichtlinie 2006/95/EG

Dokumentations-Bevollmächtigter:

Person authorised to compile the technical file:

Personne autorisée à constituer le dossier technique:

Persona facultada para elaborar el expediente técnico:

Persona autorizzata a costituire il fascicolo tecnico:

Mag. Gottfried Aschauer

WINTERSTEIGER AG

A-4910 Ried / I., Dimmelstraße 9

Ried /I., am 13.01.2010



Ing. Walter Aumayr
Vorstand



Mag. Gottfried Aschauer
CE-Beauftragter