





# Table of Contents

|          |   |           |
|----------|---|-----------|
| <b>1</b> | <b>Foreword</b> .....   | <b>6</b>  |
| 1.1      | Appropriate usage .....   | 6         |
| <b>2</b> | <b>General information</b> .....  | <b>7</b>  |
| 2.1      | Explanation of the symbols in the manual .....                          | 7         |
| 2.1.1    | Legend .....  | 7         |
| 2.2      | Safety rules .....  | 7         |
| 2.2.1    | Basic safety .....  | 7         |
| 2.2.2    | General safety instructions .....                                       | 8         |
| 2.2.3    | Safety instructions for the operator .....                              | 8         |
| 2.2.4    | Safety instructions for operating personnel .....                       | 8         |
| 2.2.5    | Instructions for safe transport .....                                   | 9         |
| 2.2.6    | Safety during operation .....   | 9         |
| 2.2.7    | Safety instructions for maintenance, repair and fault elimination ..... | 10        |
| 2.2.8    | Safety during work on electrical system .....                           | 10        |
| 2.2.9    | Safety during work on pneumatic system .....                            | 10        |
| 2.3      | Warning signs .....   | 11        |
| 2.4      | Safety devices .....  | 12        |
| 2.5      | Purpose of use .....  | 14        |
| 2.6      | Function .....  | 15        |
| <b>3</b> | <b>Technical data</b> .....   | <b>16</b> |
| <b>4</b> | <b>Transport and setup</b> .....  | <b>17</b> |
| <b>5</b> | <b>Connections and other preparations</b> .....                         | <b>18</b> |
| 5.1      | Preparation for operation .....   | 18        |
| 5.1.1    | Pneumatic system .....  | 18        |
| 5.1.1.1  | Cut off compressed air .....  | 18        |
| 5.1.2    | Coolant tank .....  | 18        |
| <b>6</b> | <b>Description of the operating elements</b> .....                      | <b>20</b> |
| 6.1      | Operating elements operating panel .....                                | 20        |
| 6.2      | Operating elements ski magazine .....                                   | 21        |
| 6.3      | Operating elements module STONE .....                                   | 23        |
| 6.3.1    | Adjustment of the grinding angle disc .....                             | 24        |
| <b>7</b> | <b>Charging of the ski magazine</b> .....                               | <b>25</b> |
| <b>8</b> | <b>Load - save - delete grinding program</b> .....                      | <b>26</b> |
| 8.1      | Load grinding program .....   | 26        |
| 8.2      | Save grinding program .....   | 27        |
| 8.2.1    | Save as .....   | 29        |
| 8.3      | Delete grinding program .....   | 29        |
| 8.4      | Program info .....  | 30        |

|           |   |           |
|-----------|---|-----------|
| <b>9</b>  | <b>Working with the machine</b>                             | <b>31</b> |
| 9.1       | Handling when working with the ski magazine                 | 31        |
| 9.2       | Handling when working without ski magazine                  | 32        |
| 9.2.1     | Grinding a snowboard  | 33        |
| 9.2.2     | Grinding a cross-country ski                                | 34        |
| 9.2.3     | Grinding a ski with a width of between 135 and 180 mm.      | 35        |
| 9.2.4     | Grinding a Rocker or V-Shape ski                            | 37        |
| <b>10</b> | <b>Change grinding program</b>                              | <b>39</b> |
| 10.1      | Automatic ski recognition                                   | 39        |
| 10.2      | Tips for input fields                                       | 40        |
| 10.3      | Adjustment sequence of operations                           | 41        |
| 10.3.1    | Selection of the processes                                  | 41        |
| 10.3.2    | Adjust feed speed   | 43        |
| 10.3.2.1  | Variable feed speed   | 43        |
| 10.3.2.2  | Delete the sequence of operations                           | 43        |
| 10.3.2.3  | Variable holding-down pressures with the snowboard programs | 44        |
| 10.4      | Stone unit - change parameters                              | 45        |
| 10.4.1    | Reduce grinding force for children ski                      | 45        |
| 10.4.2    | Speed parameters  | 46        |
| 10.4.2.1  | Detail parameters stone unit                                | 47        |
| 10.4.3    | Structure selection   | 49        |
| 10.4.4    | Structure parameters  | 50        |
| 10.4.4.1  | Chevron structure   | 53        |
| 10.4.4.2  | Racing structures   | 55        |
| 10.4.4.3  | Structure preview   | 56        |
| 10.4.5    | Manual functions stone unit                                 | 57        |
| 10.4.6    | Check and adapt stone diameter                              | 58        |
| 10.5      | Disc unit - change parameters                               | 60        |
| 10.5.1    | Disc parameters   | 61        |
| 10.5.1.1  | Detail parameters disc unit                                 | 62        |
| 10.5.2    | Manual functions disc unit                                  | 63        |
| <b>11</b> | <b>Variable grinding force</b>                              | <b>64</b> |
| 11.1      | Changing the grinding force parameters                      | 65        |
| 11.1.1    | Copy - paste curve  | 65        |
| <b>12</b> | <b>General adjustment</b>                                   | <b>66</b> |
| 12.1      | Stop after x skis   | 67        |
| 12.2      | Ski magazine return   | 67        |
| 12.3      | Language selection  | 67        |
| 12.4      | Change date, time and display brightness                    | 68        |
| 12.5      | Operating hours   | 69        |
| 12.6      | Ski/board counter   | 70        |
| 12.7      | Alarm history   | 71        |
| 12.8      | Factory values  | 72        |
| 12.9      | List of components  | 73        |
| 12.9.1    | Password for component list                                 | 73        |
| 12.10     | Ski measurements  | 73        |

|           |   |           |
|-----------|---|-----------|
| 12.11     | Emulsion calculator .....   | 74        |
| 12.12     | Automatic filling of the cooling lubricant tank (optional) .....      | 76        |
| <b>13</b> | <b>Overview adjustment parameters .....</b>                           | <b>77</b> |
| 13.1      | Adjustment parameters module STONE .....                              | 78        |
| <b>14</b> | <b>Maintenance - service .....</b>                                    | <b>80</b> |
| 14.1      | General .....   | 80        |
| 14.1.1    | Cleaning the inside of the machine .....                              | 80        |
| 14.1.2    | Maintenance base machine - coolant tank - charging/discharging .....  | 81        |
| 14.1.3    | Emergency release of the sliding doors .....                          | 83        |
| 14.1.4    | Clean laser .....   | 83        |
| 14.1.5    | Battery change on the operating panel .....                           | 84        |
| 14.1.6    | General indications for proper dealing with lubricating coolant ..... | 85        |
| 14.2      | Maintenance - service module STONE .....                              | 86        |
| 14.2.1    | Changing the grinding stone .....                                     | 86        |
| 14.2.2    | Changing the diamond .....  | 87        |
| 14.2.3    | Changing the ceramic discs .....                                      | 88        |
| 14.2.4    | Carry out test run according to official regulations .....            | 88        |
| 14.2.5    | Maintenance works .....   | 89        |
| 14.3      | Maintenance schedule .....  | 91        |
| <b>15</b> | <b>Shut-down and disposal .....</b>                                   | <b>92</b> |
| <b>16</b> | <b>Declaration of Conformity .....</b>                                | <b>93</b> |

# 1 Foreword

These operating instructions must be read by the operators and by the persons responsible for the machine maintenance before initial use and serves as a supplement to the training documentation.

Damage caused by failure to follow the instructions herein will not be covered by the warranty. The user of this machine is legally bound to the casualty regulations of the country in question.

In addition, these operating instructions are confidential. It must only be accessible to authorized persons. Making it available to third parties requires the written approval of WINTERSTEIGER.

All documents are protected in accordance with copyright protection. The transfer and copying of these documents, even excerpts, and the utilization and communication of its content are not permitted, except if this was explicitly authorized in writing.

Noncompliance is punishable and establishes a compensation claim. All rights for the execution of commercial property rights are reserved by WINTERSTEIGER.

## 1.1 Appropriate usage

The machine was manufactured exclusively for normal use for ski service work (appropriate usage). Any other use is considered inappropriate. The manufacturer is not liable for any damage resulting from inappropriate use. The user takes full responsibility in such cases.

Appropriate usage includes following the operating, maintenance and repair provisions set out by the manufacturer. Any applicable accident prevention specifications and other generally accepted safety and medical regulations are also to be obeyed.

Any changes to the machine by the user renders manufacturer liability null and void with regards to any resulting damages.

We constantly try to improve our products and therefore reserve the right to make any changes or improvements we feel are appropriate. We are, however, not obligated to extend these changes or improvements to already delivered machines or devices.

All images, dimensions and weight specifications in the operating instructions are non-binding.

### Original operating manual

© Copyright 2007 by



WINTERSTEIGER AG :: A-4910 Ried/I Dimmelstrasse 9

Tel. +43 7752 919-0

e-mail: office@wintersteiger.at

Author and graphics: Franz Badegruber

Design: Maria Marek-Pollhammer

## 2 General information

### 2.1 Explanation of the symbols in the manual



**DANGER** describes a danger with a high degree of risk, which will result in death or severe injury if it is not prevented.



**WARNING** describes a danger with a medium degree of risk, which could result in death or a severe injury if it is not prevented.



**CAUTION** describes a danger with a low degree of risk, which could result in small or moderate injury if it is not prevented.



This exclamation point refers to a possible damage or destruction of the product, the process and/or its environment.



Special information for the practical work or general recommendations can be found here.

#### 2.1.1 Legend

Following abbreviations are used in this operating manual:

- SE = side edge
- BE = base edge
- SEG = Side edge grinder belt (with module PREGRIND)

## 2.2 Safety rules

### 2.2.1 Basic safety

- This machine was built according to the latest technology and generally accepted safety rules. However, risks for the user or third parties or damage to the machine and other material assets may occur during use if the machine:
  - is operated by untrained personnel without proper instructions,
  - is not used according to regulations,
  - is improperly repaired or maintained.

## 2.2.2 General safety instructions

- Connection of the device to the mains should only be carried out by an electrical engineer who knows the country-specific regulations of the local power supply companies exactly and adheres to them strictly.
- Observe correct supply voltage! Connected loads are visible on the type plate under the main switch. Check whether these values are in agreement with network voltage.
- The machine may only be operated with original WINTERSTEIGER spare parts or consumables. Any use of foreign material shall be at the risk of the operator and will invalidate the machine warranty. This especially applies to grinding emulsions and machine cleaners.
- Due to the high air humidity contents produced during the grinding process, adequate ventilation must be provided!!
- WINTERSTEIGER recommends using an emulsion filter for this machine.

## 2.2.3 Safety instructions for the operator

- In addition to the mandatory accident prevention and health & safety regulations in force in the place of use, generally accepted specialist rules for safe and professional work are to be observed.
- The employer is to ensure the operating personnel to wear personal protective equipment as this is prescribed by local regulations.
- First-aid equipment (first-aid box, etc.) is to be stored within reach! Location and operation of fire extinguishing equipment are to be specified. It is necessary to install fire detection and fire fighting systems.
- The operator/user of the machine must not carry out any alterations, additions or conversions on the machine that may impair safety without prior permission WINTERSTEIGER AG!
- Only employ trained or instructed personnel. Staff responsibilities for the operation, equipment, maintenance, and repair of the machine are to be clearly defined! A machine operator is to be selected who should be responsible for machine and personnel. Personnel that need training, instruction, or personnel unertaking in general training may only operate the machine under the constant supervision of an experienced skilled worker!

## 2.2.4 Safety instructions for operating personnel

- The operating instructions must constantly be accessible in the place of use of the machine!
- Relevant accident prevention regulations and other generally accepted safety and occupational medical rules are to be observed.
- The machine may only be used in technically faultless condition and according to regulations, with full knowledge of safety and risks, in accordance with these operating instructions! Faults impairing safety must be eliminated immediately!
- The operator is to wear personal protective equipment as prescribed by local regulations!
- For all works concerning operation, conversion, and settings of the machine and its safety systems, observe the entry and exit processes as well as emergency shut-down in accordance with operating instructions!
- When carrying out inspection, maintenance and repair on the machine, any safety measures within the frame of these activities must be observed!



### 2.2.5 Instructions for safe transport

- Wear protective helmet, safety footwear, and protective gloves during transport!
- Never stand under hanging loads!
- Only use suitable and tested lifting gear!
- Only use suitable, standardised and tested lifting gear (fork lift, automatic crane, hall bridge crane) and lifting tackles (round loops, lifting belts, lifting sling, and chains) for transport to the installation site.
- Always take maximum load bearing capacity into account when selecting lifting gear and lifting tackles!
- Please see Technical Data ([see chapt. 3 Technical data, page 16](#)) for dimensions and weight.
- Please always ensure that the machine is transported without shocks and blows.
- Observe the icons on the packaging.
- Notify the supplier of any transport damage and/or missing parts immediately.
- Always transport switch cabinets vertically!
- Only fasten transport boxes and frames to the labelled anchors!
- Always secure loads to be transported against falling or tipping over!
- All transport safeguards may only be removed after installation!

### 2.2.6 Safety during operation

- The machine may only be operated by trained persons.
- The machine may only be operated in assembled operable condition.
- The machine may only be operated once all safeguards ([see chapt. 2.4 Safety devices, page 12](#)) and safety-related systems, e.g. detachable safeguards, covers, are available and serviceable.
- Set-up operation may only be carried out by qualified personnel, because work on terminal switches and machine components may trigger undesirable movements that could lead to serious injuries.
- The machine is to be checked at least once per shift to detect any external visible damage and defects! Any occurred changes (including operating behaviour changes) are to be notified immediately to the responsible department/person! The machine is to be shut down and secured if necessary!
- The machine should never be left unattended during operation!
- Entry and exit processes, control lamps are to be observed in accordance with the operating instructions!
- When shutting down the machine, it should always be switched off by the operating personnel and secured against re-setting by unauthorised persons.
- The mains plug is to be pulled out prior to each relocation or for machine interventions!
- Do not operate the machine near flammable materials!
- Only operate the machine with according working clothes:
  - long-sleeved outer clothing
  - long pants

- protective gloves in suitable material
- Do not touch rotating parts during operation!
- Be aware that parts continue to rotate e.g. after operating the emergency OFF key or opening the protective hood!
- Do not touch the feed with your hands during operation and do not deposit or store objects in this area!
- Two emergency OFF push buttons ensure switch-off in case of emergency. They are located on the machine control panel as well as at the end of the last module.
- In case of jammed skis or boards, the emergency OFF key must first be actuated. Afterwards, the ski or board can be removed.

### 2.2.7 Safety instructions for maintenance, repair and fault elimination

- Regular check/inspection intervals prescribed or specified in the operating instructions are to be adhered to.
- All maintenance and repair works can only be carried out once the main switch is switched off. Manual interventions on a running machine can lead to serious accidents and are therefore prohibited. If it is necessary to switch on the machine during such activities, this may only be within permissible operating modes upon observing special safety measures.
- Safe and environmentally-friendly disposal of operating supplies and auxiliary materials as well as replacement parts is to be ensured.

### 2.2.8 Safety during work on electrical system

- In case of faults of the machine electrical equipment, the machine is to be switched off immediately with the main switch!
- Works on machine electrical system may only be performed by electrical engineers according to electrotechnical rules! Only electrical engineers may have access to the machine electrical equipment and perform works on it. Keep the switch cabinets closed at all times as soon as they are unattended.
- Never work on live parts! Machine parts requiring inspection, maintenance and repair works must be switched off. Operating supplies which were used for enabling the machine are to be secured against unintended or automatic reset (close fuses, block disconnect switch, etc.). The enabled electrical components must first be checked for deadness, then grounded and short-circuited, and adjacent live components must be insulated!
- Only original fuses with prescribed current strengths are to be used! Never repair or connect defective fuses. Replace fuses only with same-type fuses.
- Changes on the control programme can impair safe operation. Programme changes may only be carried out with the manufacturer's authorisation.
- Correct grounding of the electrical system must be ensured through a protective earth conductor system.

### 2.2.9 Safety during work on pneumatic system

- Works on pneumatic equipment may only be carried out by qualified skilled personnel with special knowledge and experience in this subject!
- All pipes, hoses, and pipe fittings are to be checked regularly for leakage and externally visible damage! Damaged parts are to be exchanged immediately!
- If system parts and delivery pipes need opening, they must be unpressurised before starting repair works!
- Keep your hands off the machine parts after switching on the compressor! The produced work pressure may lead to the pneumatic cylinder's basic position being displaced due to pressure inflow.

### 2.3 Warning signs



**Risk of injury!**

Regular checks must be made to ensure that the warning labels are still attached to the machine. Illegible or missing warning labels must be replaced immediately.



Wear gloves!

Order number: 78-150-678



Attention! Hot surface!

Order number: 78-150-121



Carefully read operator's manual before handling the machine and observe instructions and safety rules when operating!

Order number: 78-166-001

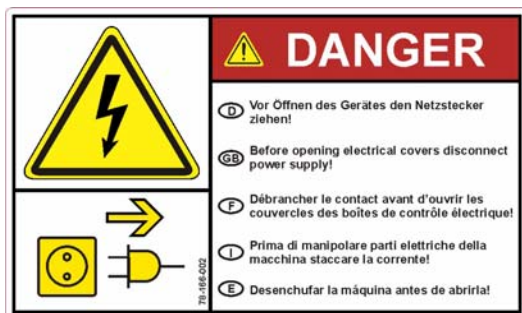

Before opening electrical covers disconnect power supply!

Order number: 78-166-002



Before changing the stone, check max. permitted rpm of new stone!

Order number: 78-166-005



Risk of stone getting out of balance! Never spray the stone when it is stationary!

Order number: 78-166-021



Keep hands out of magazine during operation!

Order number: 78-166-003



Keep hands out of feed during operation!

Order number: 78-166-009

Order number: 78-166-009

## 2.4 Safety devices

The following safety devices must not be removed during operation:

- [1] Sliding door front side
- [2] Rear cover
- [3] Front cover

as well as any other protections and covers that ensure safe and injury-free operation!

Opening of the sliding door (1):

- the main switch must be switched on
- press the stop button
- the sliding door can be opened after approx. 15 seconds or after report on the display.

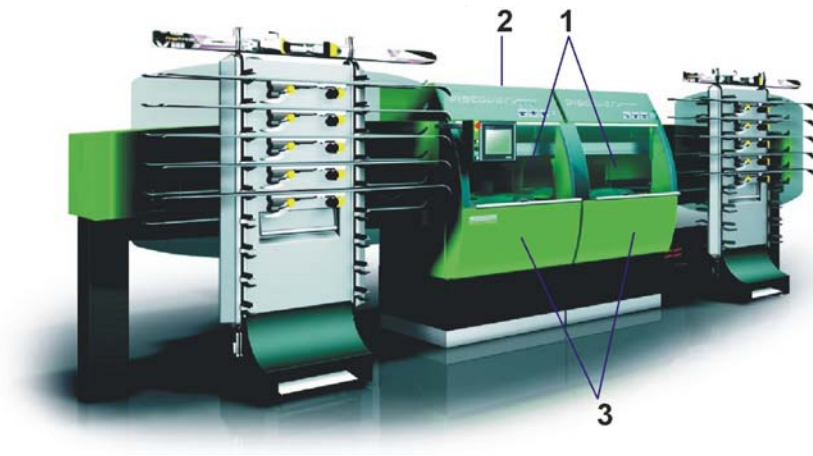

## 2.5 Purpose of use

The machine is designated only for the following processes on alpine skis, cross-country skis and snowboards:

- Stone pre- and fine grinding
- Processing of side and base edge, grinding angle can be variable

| in mm        | SKI  | SNOWBOARD              | XC-SKI | WIDE SKI           |
|--------------|------|------------------------|--------|--------------------|
| max. width:  | 140  | 340                    | 70     | 180 (Special mode) |
| min. width:  | 55   | 200 (with adapter 150) | 40     | 110                |
| max. length: | 2100 | 2100                   | 2100   | 2100               |
| min. length: | 920  | 1000                   | 920    | 1000               |

**!** Wide skis with a maximum width of 135 - 180 must be ground in "EXTRA" mode without the ski magazine (see [chapt. 9.2.3 Grinding a ski with a width of between 135 and 180 mm., page 35](#))! The minimum width must be no less than 110 mm.

Rocker and V-Shape skis can be ground with the ski magazine in "EXTRA" mode (see [chapt. 9.2.4 Grinding a Rocker or V-Shape ski, page 37](#)).

XC skis must be ground in "EXTRA" mode without the ski magazine (see [chapt. 9.2.2 Grinding a cross-country ski, page 34](#)).



Twin tip

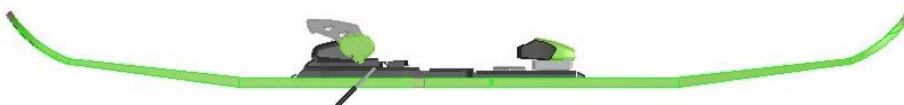

Rockered

**!** In the event that any of the above instructions is not adhered to, WINTERSTEIGER company will refuse any liability for any damage caused!

## 2.6 Function

- Menu control via Touch Screen Display
- Automatic charging and discharging for 16 skis, or manual charging for one snowboard
- Two separate feed modules for optimum throughput
- Ski stoppers are clamped up by an elastic band or dummy sole

### Module STONE1 and 2 [S]

- Stone grinding with more cycles (the ski is moving back-and-forth - processing both directions)
- Wide application of grinding pressure from below - pneumatic for uniform grinding
- Stone oscillation for extended stone life
- Side edge processing and base edge processing

### 3 Technical data

| Type  | Discovery SS  |
|---|---|
| Nominal voltage; frequency; capacity; nominal current; fuse protection min./max.: | 3N AC x 380-415 V; 50/60 Hz; 14.8 kW; 27.6A; 32/32 A  |
| Allowed ambient temperature:  | + 10 to 30 °C   |
| Dimensions:   | see following graphic   |
| Operating pressure:   | 7 bar   |
| Air consumption:  | 200 l/min<br><b>Use only dry and oil-free air!</b>  |
| Total weight:   | approx. 3345 kg   |
| Volume water tank:  | 450 litres  |
| Max. grinding stone diameter:   | 300 mm  |
| Min. grinding stone diameter:   | 210 mm  |
| Diameter of ceramic discs:  | 154 mm  |
| Diameter of ceramic discs for for kids ski (option):                              | 150 mm  |
| Effective depth of ceramic discs:   | ca. 25 mm   |
| Noise emission:   | In an average grinding process the continuous pressure sound level is approx. 83 dB(A) at a distance of 1 meter (3 ft). |

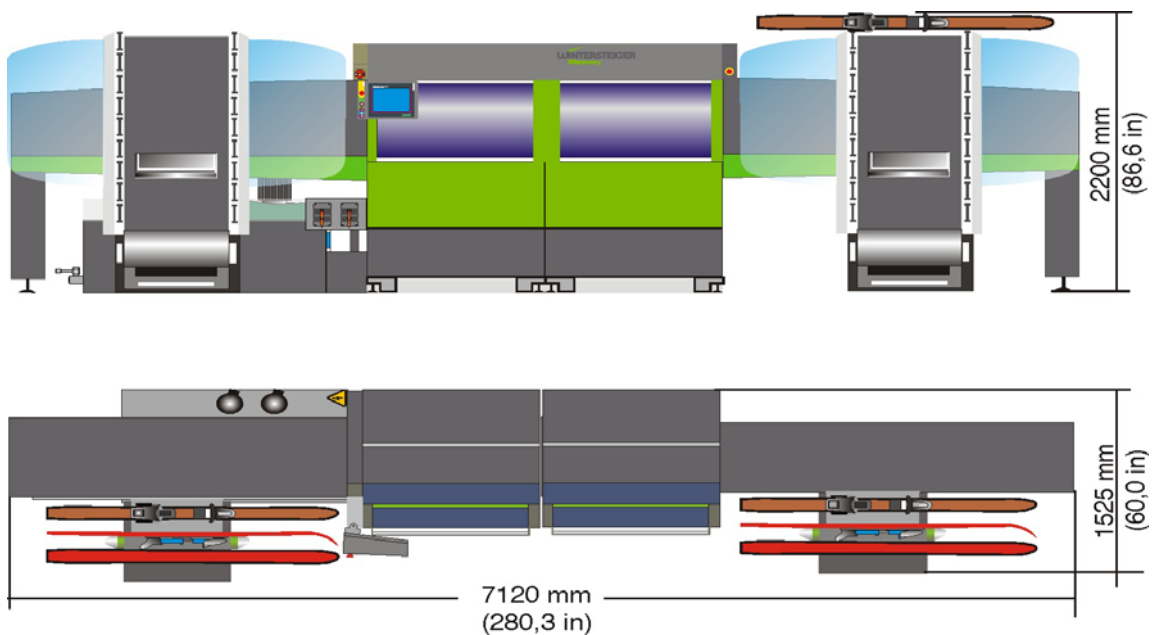



## 4 Transport and setup

- The floor must be suitable for min. area load of 15000 N/m<sup>2</sup>
- See following graphic for transport by highlift truck
- By removing the operating panel, opening the sliding doors and demounting the sliding-door frame the machine has a transport width of 880 mm (see following graphic).
- Align the machine horizontally and vertically with a water level by means of the adjusting feet [A]!
- Setup and installation of the Discovery must be carried out by an WINTERSTEIGER technician!
- Workplaces see illustration

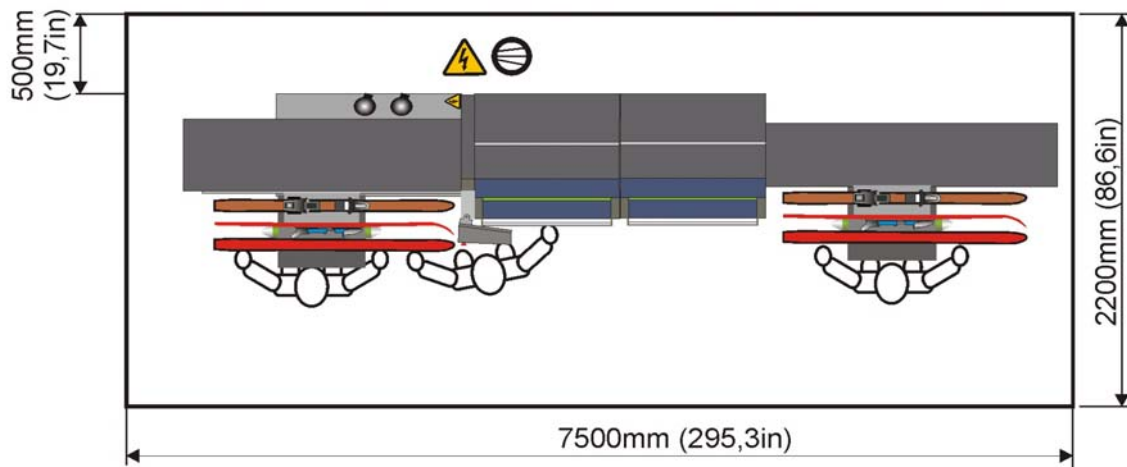
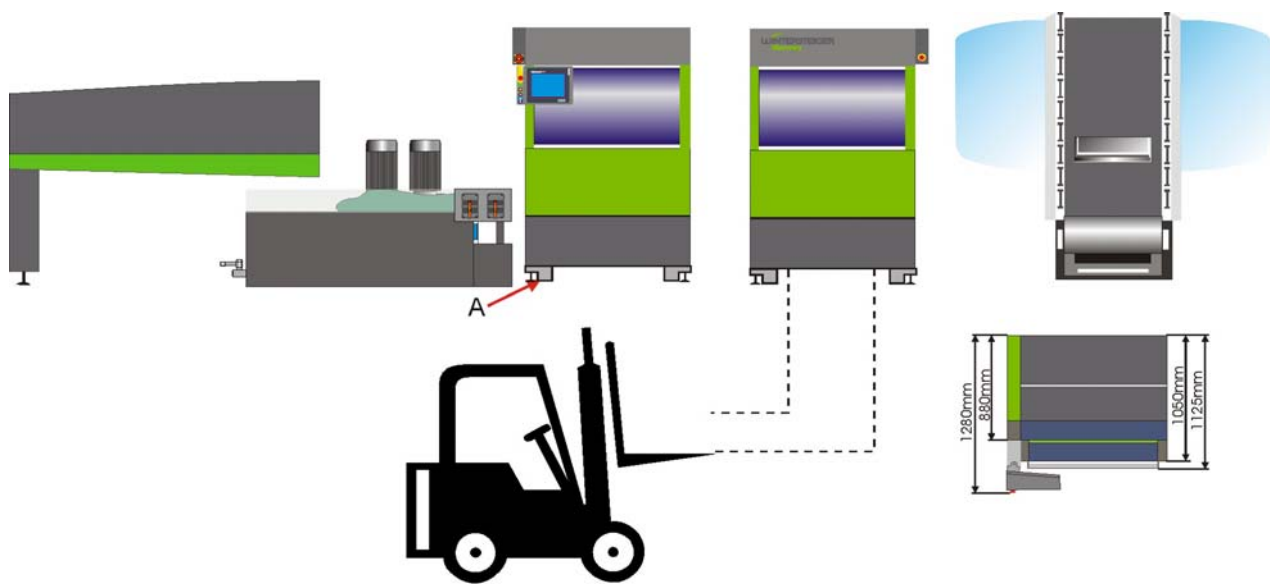

## 5 Connections and other preparations

- Remove the safety device of transport
- Connect compressed air
- Adjust air compressor to 7 bar (101 psi)
- Installation only by skilled electricians
- Observe the correct voltage. The machine voltage is shown on the data plate!
- Note the correct rotating direction of the motors. See red arrows on the grinding units. Correction of rotating direction should only be made by skilled electricians!
- A supply of water near the machine will facilitate changing the coolant and the refilling.



**It is pointed out that the use of residual current devices are not recommended, as the rotational speed controller uses a frequency converter with supply filter. In the case of a malfunction the sensitivity of the residual current circuit-breaker will be reduced due to the existing position of direct current. Protection measures have to comply with local regulations and codes of practice.**

**If, however, because of safety-technical reasons the use of residual current devices is mandatory, they should be suitable for direct, alternating, high frequency and earth current applications (e.g: ABB model series F804, or equivalent devices).**

### 5.1 Preparation for operation



**For your safety!**

**Check whether all safeguards and covers are mounted!**

#### 5.1.1 Pneumatic system

- Operating pressure must be 7 bar at system pressure manometer [A], otherwise do not use the machine!
- The pressure regulator [B] is used for the pressurization of the motors and must not be adjusted!

##### 5.1.1.1 Cut off compressed air

- Cut off compressed air by the stop valve [E].



**Turn off the air pressure at night!**

**Air pressure has to be switched on and show a pressure of 7 bar before switching on the machine!**

#### 5.1.2 Coolant tank

- Use only water-emulsion mixture!
- Machine must not be cleaned or operated with water alone!
- Do not clean the machine with the help of a high-pressure cleaner! In the event that this instruction is not adhered to, WINTERSTEIGER will refuse any liability and guarantee for any damage caused.
  - Observe level of coolant according to mark at the level indicator [C].
  - Attach filter bag to outlet [D].

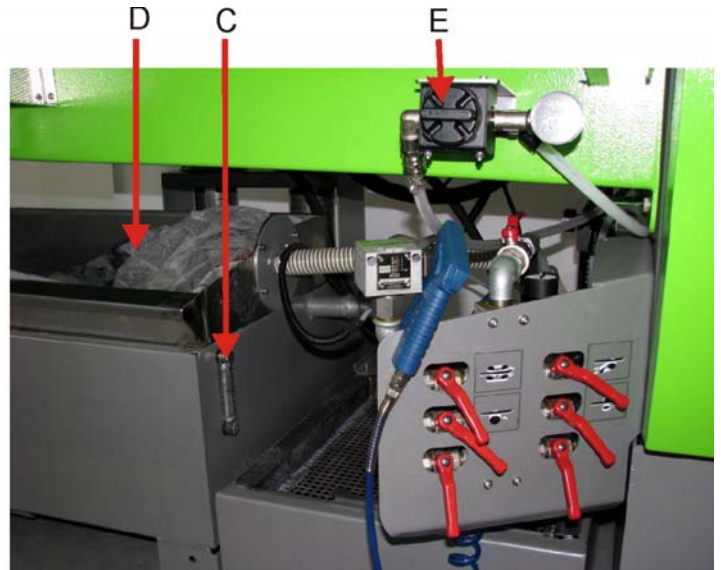
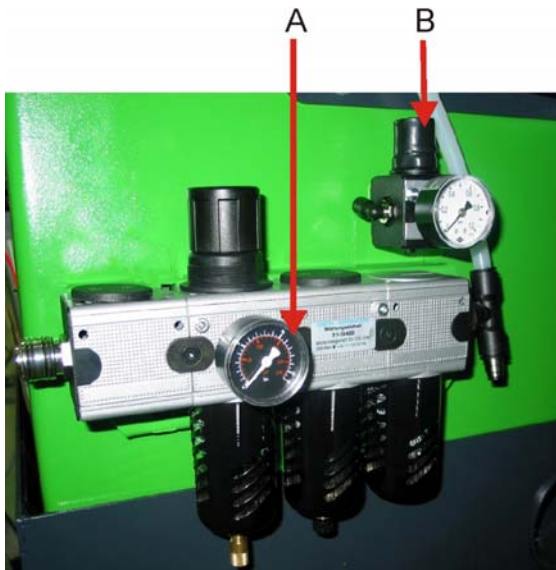

## 6 Description of the operating elements

### 6.1 Operating elements operating panel

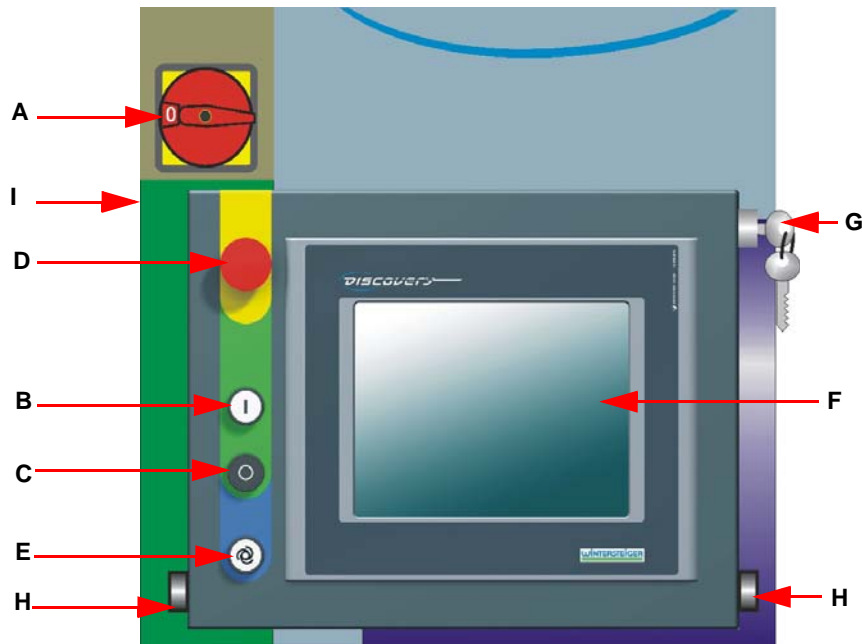

**A: Main switch:**

Used for switching on and off the complete power supply. The main switch is situated above the operating panel.

**B: Start button:**

- Used for switching on the machine. The display will show the start image when the power supply is working properly.

**C: Stop button:**

- When no ski is being processed, the machine switches off when the stop button is pressed
- When still working, the machine finishes operation and discharges the ski (board) quickly after pressing of stop button

**D: Emergency stop button:**

- Shuts off machine in case of danger.



**This key remains down and switching the machine on with [B] key again will not be possible! Pulling out the key will unlock it, allowing key to return to its initial position - machine can now be switched on with [B] key again.**

**E: Start working process**

- By actuating the switch [E] processing starts and the displayed program will be activated automatically. The charging just starts when the machine is ready for operation.

**F: Touch-Screen monitor**

- Touch-Screen function of the display guarantees optimum control of the machine. A light touch activates the respective field.



**Do not touch the screen with sharp objects like biro, knife etc. A special pen can be ordered at WINTERSTEIGER (Art. no. 7000-0811-V01).**

**G: Key switch manual charging**



**Manual charging is for grinding snowboards and cross country skis. It can also be used for skis in case of a breakdown of the ski magazine.**

- The ski magazines can be removed when turning the key switch to manual charging.

**H: Start working process without ski magazines**



**Risk of injury!**

**The charging starts automatically. Therefore be careful when working in the charging area. Keep hands away during charging process!**

- Working process with manual charging can be started by actuating the two keys [H] simultaneously.

**I: USB-port**

- USB-port for any program updates

**6.2 Operating elements ski magazine**

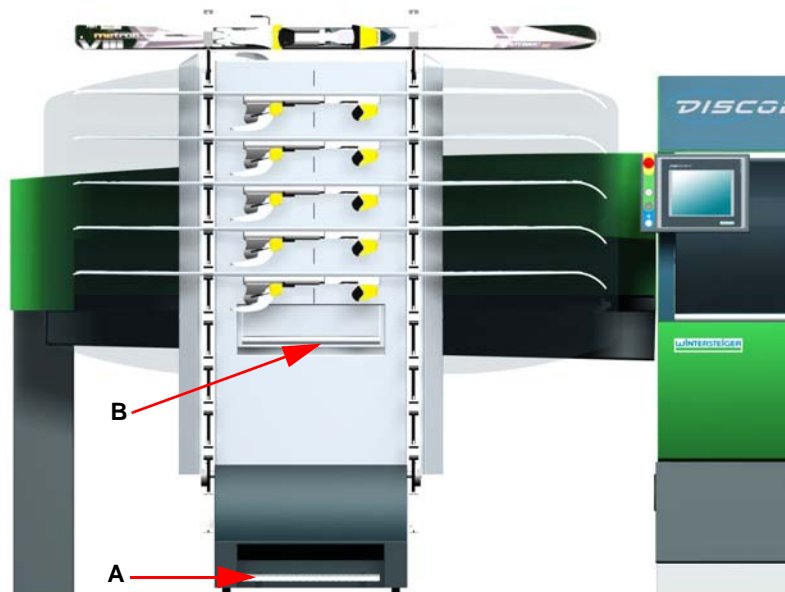

**A: Pedal ski transport**

- By a short actuation of the pedal [A] the magazine moves to the next position. By a continuous actuating of the pedal the magazine moves until the first ski reaches the conveyor belt or the pedal is released.

**B: Unlocking the ski magazine**

- Push up the bow [B] and remove the ski magazine by pulling.



**Risk of injury!**

**If the ski magazine is removed during working process and if the key switch was not turned to manual charging, the emergency stop is activated!**

### 6.3 Operating elements module STONE

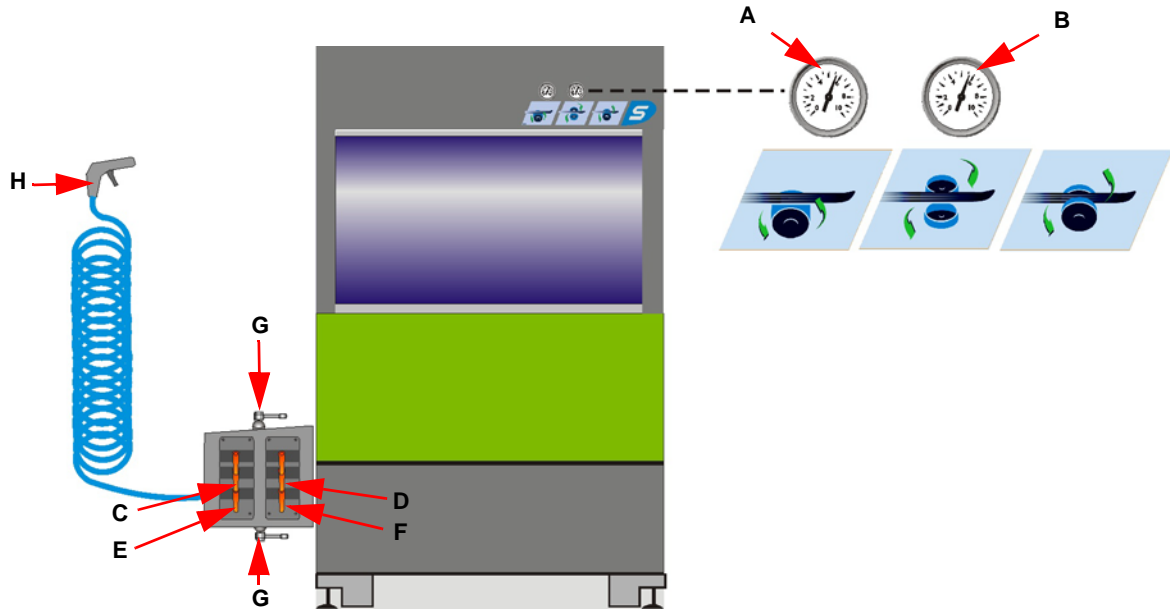

- A: Grinding force stone grinding
  - The grinding force of the grinding stone is shown on manometer [A].
- B: Grinding force disc grinding
  - The grinding force of the SE and BE processing is shown on manometer [B].



**Adjustment of grinding force for stone and disc grinding (see [chapt. 10.4 Stone unit - change parameters, page 45](#) and [chapt. 10.5 Disc unit - change parameters, page 60](#)).**

#### Module 1:

- C: Ball valve coolant supply - high pressure nozzle stone
  - This handle regulates amount of coolant supplied to the high pressure nozzle of stone unit. Spraying unit for grinding stone should be completely open if possible.
- D: Ball valve coolant supply - disc unit
  - This handle regulates amount of coolant supplied to the spraying nozzle of disc unit.

#### Module 2 (option):

- E: Ball valve coolant supply - high pressure nozzle stone [module2]
  - This handle regulates amount of coolant supplied to the high pressure nozzle of stone unit. Spraying unit for grinding stone should be completely open if possible.
- F: Ball valve coolant supply - disc unit [module2]
  - This handle regulates amount of coolant supplied to the spraying nozzle of disc unit.

#### Modul 3 (option):

- Two additional ball valves regulate amount of coolant supplied to the high pressure nozzle of stone unit and disc unit.

G: Central stop valves cleaning

- These two handles close all ball valves to allow cleaning of the machine with the cleaning hose.

H: Cleaning hose for cleaning of the machine

### 6.3.1 Adjustment of the grinding angle disc

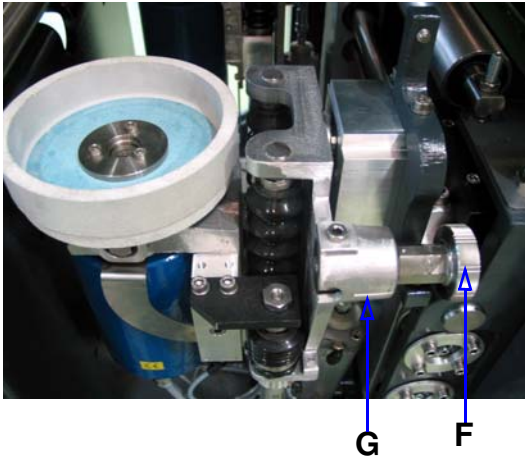

- Adjust by twisting the marked hand wheel [F] to notch [G].

**Combined grinding angles for SE and BE: tolerance +/- 0.25°**

| Position | Angle BE | Angle SE | effective edge angle |
|----------|----------|----------|----------------------|
| 1        | 1°       | 89°      | 90°                  |
| 2        | 1°       | 88°      | 89°                  |
| 3        | 0.75°    | 87.25°   | 88°                  |
| 4        | 0.75°    | 86.25°   | 87°                  |
| 5        | 2°       | 88°      | 90°                  |
| 6        | 3°       | 88°      | 91°                  |
| 7        | 4°       | 87°      | 91°                  |



**Adjust left and right side equally! The adjusted grinding angle has to be adopted to the module PREGRIND if available.**



## 7 Charging of the ski magazine

- Switch on main switch and press start key of the operating panel.

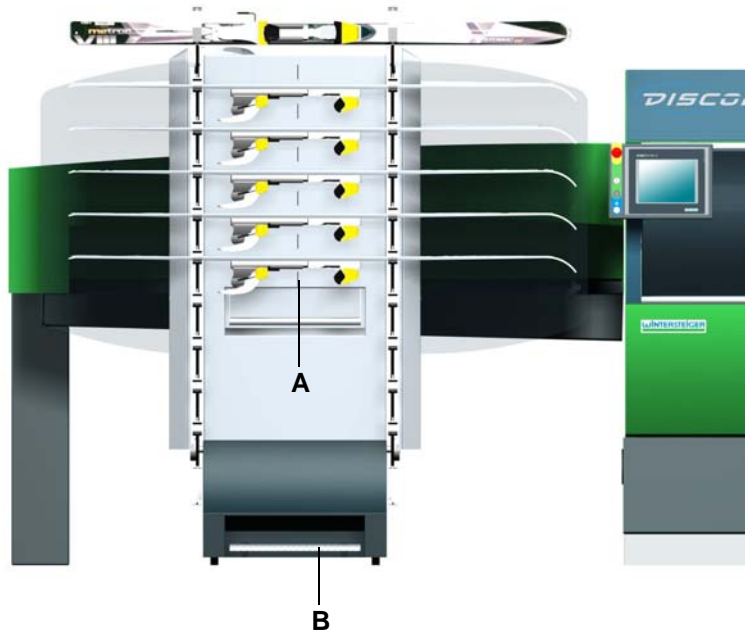

- i** Ski stoppers have to be clamped up with an elastic band. Take care that ski stoppers, which stick out compared to the ski, are 15 mm above base edge of the ski! Put the ski upside down into the ski magazine. The middle of the ski binding has to be at marking [A]. Ski tip must be on right side.

- By a short actuation of the pedal [B] the magazine moves to the next position. By a continuous actuating of the pedal the magazine moves until the first ski reaches the conveyor belt or the pedal is released.

**CAUTION** Risk of injury!

The ski magazine starts automatically. Therefore be careful when working in the charging area. Keep hands away during operation of ski magazine! Do not place or lean any objects on the ski magazine!

If a ski gets stuck in the machine during processing:



- press emergency stop button [D]
- after 50 seconds the doors can be opened
- remove ski or board
- switch machine on again

**!** When actuating the emergency stop button the ski/board may be damaged!

## 8 Load - save - delete grinding program

- Switch on main switch.
- Press start key.  
After a short initialization the main screen is shown

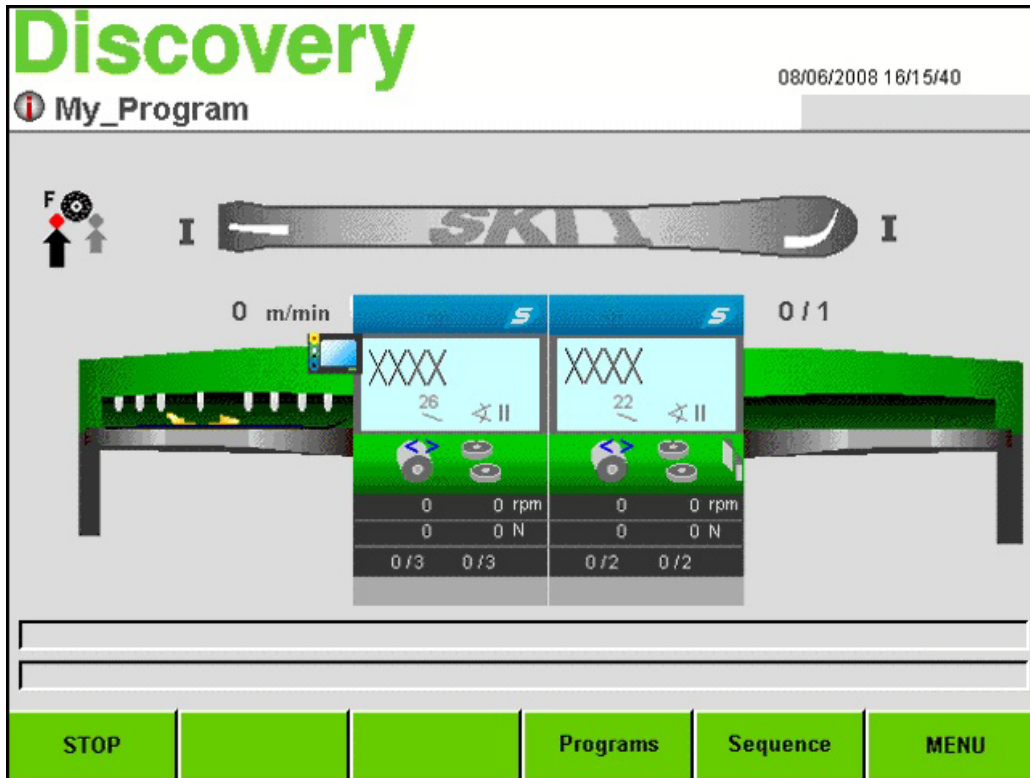

### 8.1 Load grinding program

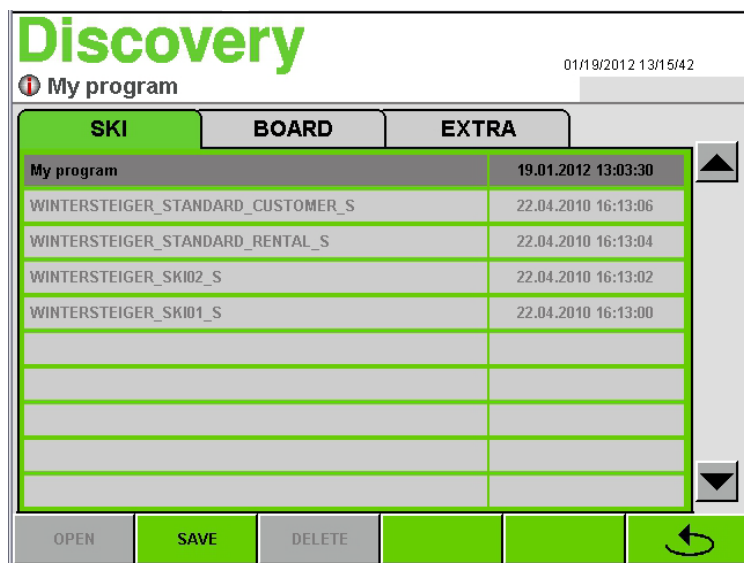

By actuating the key "Programs" the list with all preset WINTERSTEIGER grinding programs is opened.

This list contains three different categories:

- SKI
- BOARD
- EXTRA (e.g.: cross-country ski)
- Therefore select the respective category according to ski or board which has to be ground by actuating the respective register.

Each category includes two preset programs.

Select desired program by touching the respective line, then press key "OPEN".

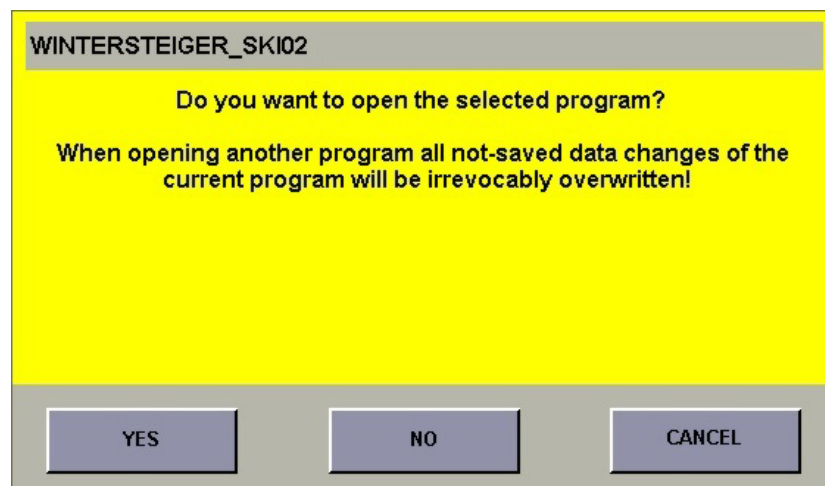

- The changes made in the previous program can be adopted. Therefore the screen in the margin appears.
- By actuating the key "YES" the new selected program will be opened without saving the changes of the previous program.
- By actuating the key "NO" or "CANCEL" you go back to the program list to save the changed program, if necessary.

## 8.2 Save grinding program

By actuating the key "Programs" in the main screen you open the list with the grinding programs.

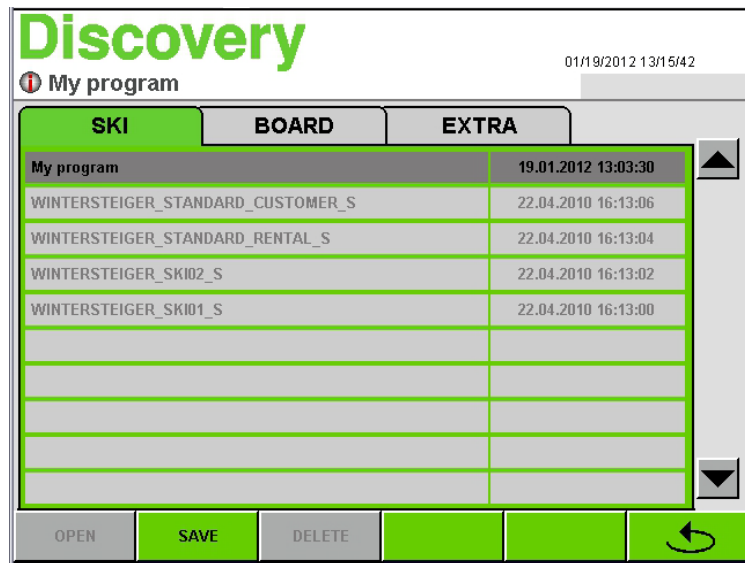

The current program is shown inversely.

**i** The preset WINTERSTEIGER programs are write-protected (shown light grey). They can be changed but have to be saved with another name then (Save as).

By actuating the key "SAVE" the following screen appears.

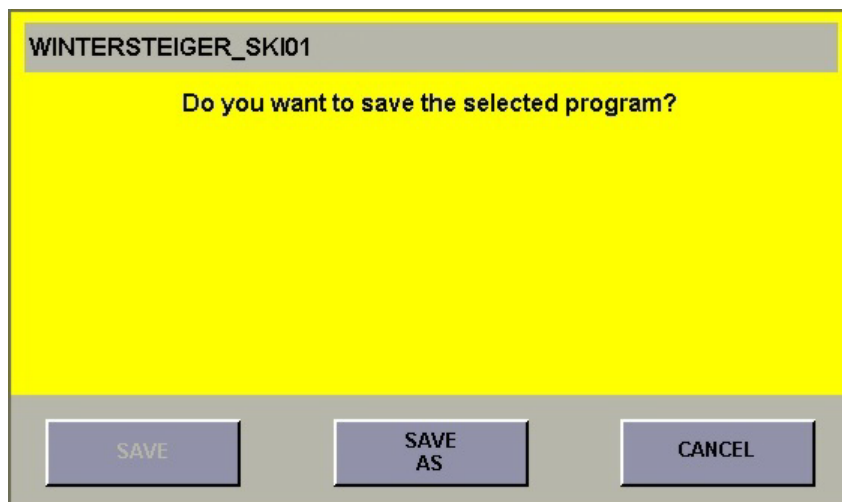

By actuating the key "SAVE" again, all changed parameters and adjustments are adopted. Then you go back to the main screen automatically.

**i** This example is shown with a write-protected program, so the key "SAVE" is shown inversely and can not be activated.

### 8.2.1 Save as



If you want to save the selected or changed program with a new name, press the key "SAVE AS".

- An alphanumeric input field is opened.
- Create the desired name by actuating the respective letters.
- By actuating the key "↑" you change between capitals and small letters.
- By pressing the key "ESC" you cancel this operation.
- By pressing the key "ENTER" you confirm input.

### 8.3 Delete grinding program

- By actuating the key "Programs" in the main screen you open the list with the grinding programs.



The current program is shown inversely.

**i** The preset WINTERSTEIGER programs are write-protected and can not be deleted. Also the current program can not be deleted.

- Select the program you want to delete and confirm with key "DELETE".

## 8.4 Program info

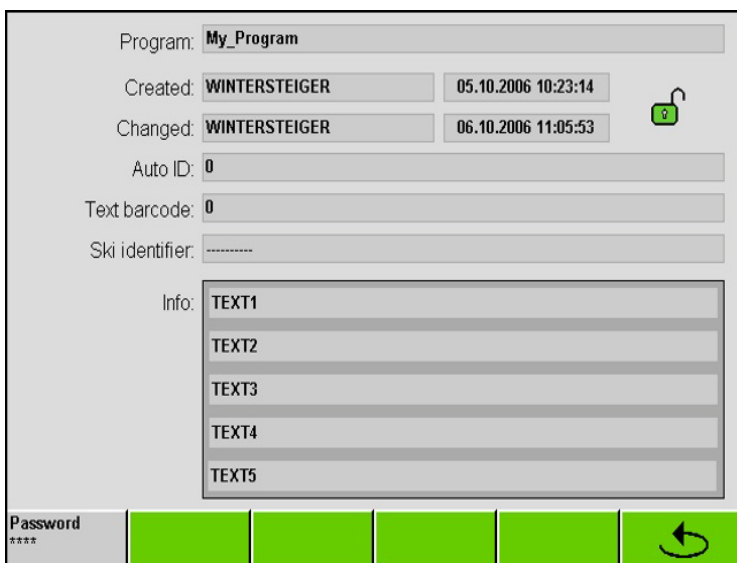

- The "Program info" window is opened by pressing the program name on the main screen.
- Program information can be saved in this window by actuating the Info text lines using the input field.
- The program info window can be write-protected - or the protection can be cancelled - by entering the password "4900" in the Password window and pressing the lock icon.

## 9 Working with the machine

- Switch on main switch.
- Press the start button.

The main screen appears after a short initialization.

### 9.1 Handling when working with the ski magazine

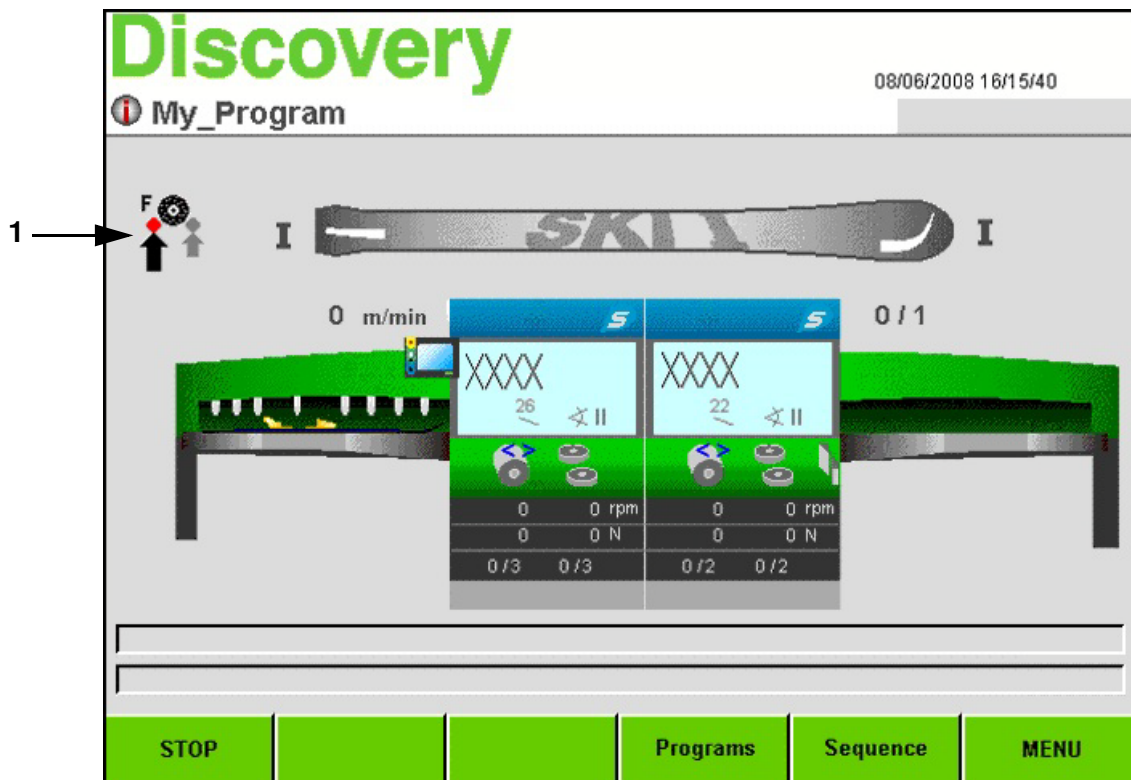

- 1) Charge the ski magazine



**Ski stoppers have to be clamped up with an elastic band.**

Take care that ski stoppers, which stick out compared to the ski, are 15 mm above base edge of the ski!  
Put the ski upside down into the ski magazine. The middle of the ski binding has to be at marking [A]. Ski tip must be on right side.

- 2) Check if the discharging magazine is ready for charging skis.

- 3) Open desired program, adjust grinding angles for edge grinding processes if necessary.

**!** **Reduce grinding force [1]**  
 When grinding children skis, it is imperative to reduce the grinding force through the selection of the small arrow [1].

**CAUTION** Risk of injury!

The ski magazine starts automatically. Therefore be careful when working in the charging area. Keep hands away during operation of ski magazine! Do not place or lean any objects on the ski magazine!

- 4) Then press button "Start working process".

**CAUTION** Risk of injury!

- 5) If a malfunction should occur in the charging or discharging area that is caused by a jammed ski or board, the emergency stop key must be pressed before intervening.

## 9.2 Handling when working without ski magazine

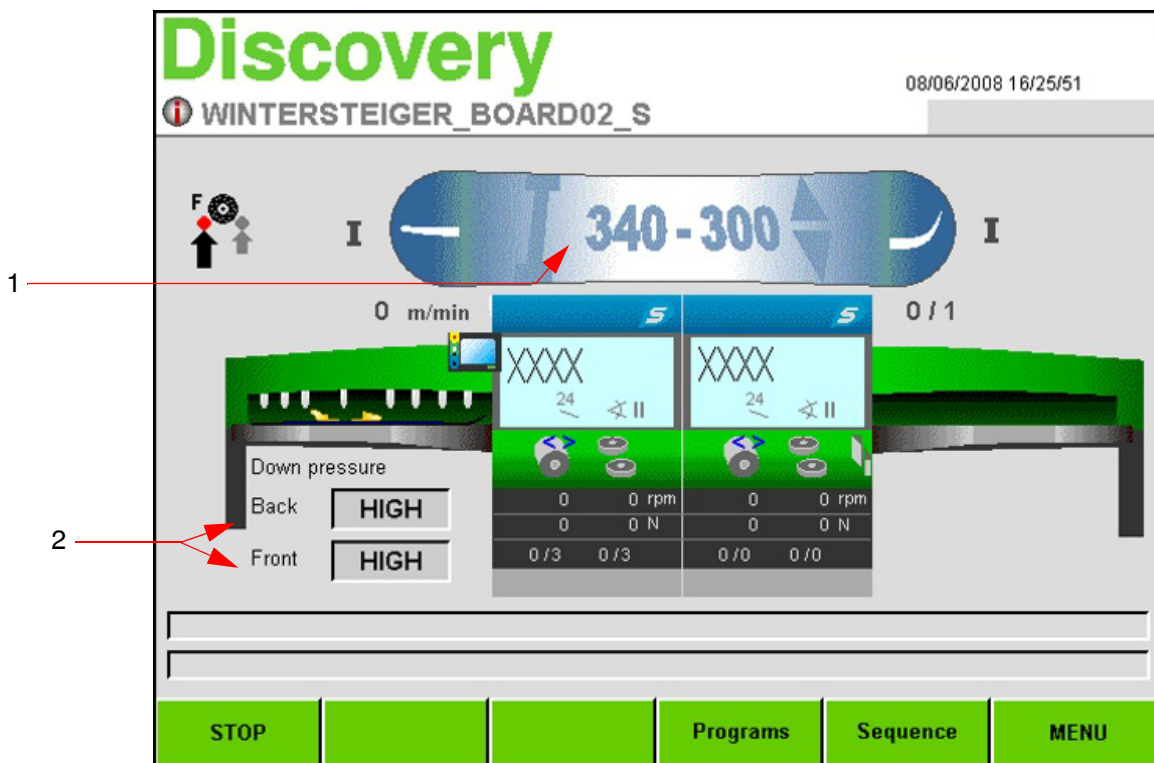

**i** Snowboards, skis with a width of between 135 and 180 mm or cross-country skis can only be ground with manual charging (without ski magazine). Manual charging can also be used for skis in case of a breakdown of the ski magazine.



### 9.2.1 Grinding a snowboard



- 1) Select the desired board program ([see chapt. 8.1 Load grinding program, page 26](#))
- 2) The angle adjustment of the edge grinding unit(s) may need to be corrected.
- 3) Turn key switch [A] to position manual charging
- 4) Remove ski magazines ([see chapt. 6.2 Operating elements ski magazine, page 21](#))
- 5) Put snowboard parallel on the front end of the charging platform up to transport stops [C].

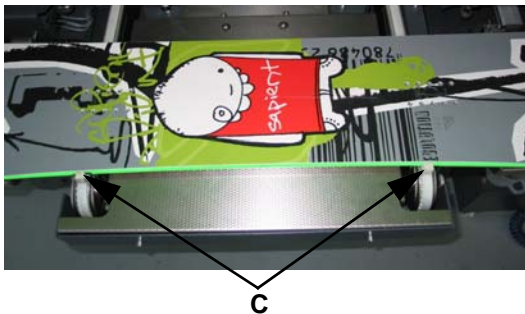

**!** Remove all loose parts (safety band, ...) before grinding the board.  
 We recommend to demount the binding, so the binding must not be cleaned after the grinding process. If you grind without demounting the binding, take care that the binding is positioned between the down-holders.

- 6) Press both buttons [B].

**The message window which appears will ask you to check the board width:**

Was the correct board width selected on the main screen [1]?

- Board I 340...300 mm
- Board II 300...270 mm
- Board III 270...240 mm
- Board IV 240...210 mm

- 7) Once these items have been checked, the message window must be closed by pressing the OK button
- 8) By keeping the two buttons [B] pressed the board is moved into the machine, centered and the grinding cycle is started.

**i** If the buttons are released early, the transport is interrupted. Charging will be continued by pressing the buttons again.

**CAUTION** Risk of injury!

Take care that there is no one near the charging and discharging areas.

When grinding snowboards, the holding-down pressure can be set different for the front and the back.

- A reduced pressure (LOW) can be assigned to the front or rear holding-down device by pressing the respective buttons [2].

**i** This application is a special advantage with convex Boards.

9) The board is transported to the discharging area after the grinding process.



**Risk of injury!**

**Do not take off the board before it was completely discharged!**

10) The next board can be charged when feeder has taken it's initial position in the charging.



**Risk of injury!**

**If a malfunction should occur in the charging or discharging area that is caused by a jammed ski or board, the emergency stop key must be pressed before intervening.**

### 9.2.2 Grinding a cross-country ski



**Prior to grinding cross-country skis, the centering adaptors (optional, order No. 8550-1111-V03) must be mounted on the centering devices of the charging unit.**

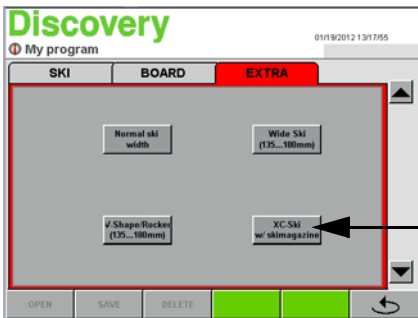

- 1) Select the "EXTRA" tab.
- 2) Select "XC ski w/ skimagazine" [1].

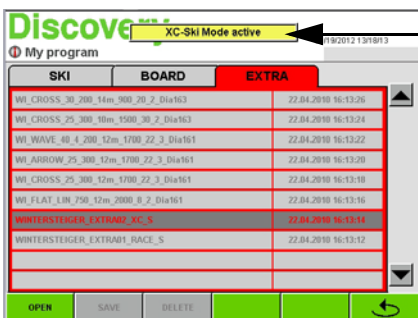

- 3) Select the desired program ([see chapt. 8.1 Load grinding program, page 26](#))



**This operating mode will be displayed in the upper screen section [2] for as long as the mode is enabled!**



- 4) Turn key switch [A] to position manual charging
- 5) Remove ski magazines ([see chapt. 6.2 Operating elements ski magazine, page 21](#))
- 6) Position the cross-country ski on the front end of the charging unit and align with the two transport stops.



**If you grind without demounting the binding, take care that the binding is positioned between the down-holders.**

7) Press both buttons [B].

The message window which appears will ask you to check the following items:

- Please check whether the centering adaptors are installed.
- Please note the selected processes! Is edge working selected?
- Please check the selected grinding force! It may be necessary to reduce the grinding force by selecting the small arrow on the main screen.

8) Once these items have been checked, the message window must be closed by pressing the OK button.

9) By keeping the two buttons [B] pressed the ski is moved into the machine, centered and the grinding cycle is started.



If the buttons are released early, the transport is interrupted. Charging will be continued by pressing the buttons again.

For safety reasons grinding only takes place with the front feeder!



**CAUTION** Risk of injury!

Take care that there is no one near the charging and discharging areas.

10) The ski is transported to the discharging area after the grinding process.



**CAUTION** Risk of injury!

Do not take off the ski before it was completely discharged!

11) The next ski can be charged when feeder has taken it's initial position in the charging.



**CAUTION** Risk of injury!

If a malfunction should occur in the charging or discharging area that is caused by a jammed ski or board, the emergency stop key must be pressed before intervening.

### 9.2.3 Grinding a ski with a width of between 135 and 180 mm.

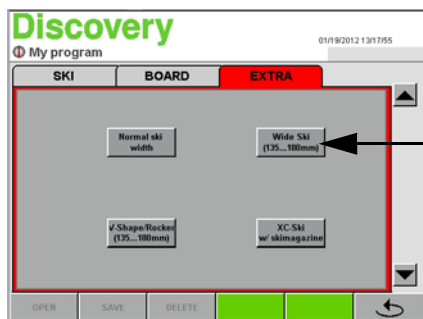

1) Select the "EXTRA" tab.

2) Select "Wide ski (135 ... 180mm)" [1].

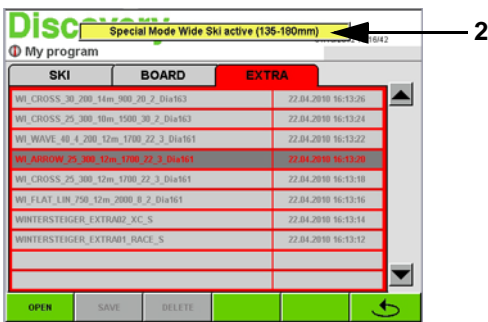

- 3) Select the desired program ([see chapt. 8.1 Load grinding program, page 26](#))



This operating mode will be displayed in the upper screen section [2] for as long as the mode is enabled!



- 4) Turn key switch [A] to position manual charging  
 5) Remove ski magazines ([see chapt. 6.2 Operating elements ski magazine, page 21](#))  
 6) Position the wide ski on the front end of the charging unit and align with the two transport stops.



If you grind without demounting the binding, take care that the binding is positioned between the down-holders.

- 7) Press both buttons [B].

The message window which appears will ask you to check the following items:

- The widest ski tip must point to the right.
  - The ski must have a width of 135-180 mm!
  - The width at the narrowest point must be 110 mm!
- 8) Once these items have been checked, the message window must be closed by pressing the OK button  
 9) By keeping the two buttons [B] pressed the ski is moved into the machine, centered and the grinding cycle is started.



If the buttons are released early, the transport is interrupted. Charging will be continued by pressing the buttons again.

For safety reasons grinding only takes place with the front feeder! To determine the ski type of the wide ski, the ski is measured prior to grinding.



Risk of injury!

Take care that there is no one near the charging and discharging areas.

- 10) The ski is transported to the discharging area after the grinding process.



Risk of injury!

Do not take off the ski before it was completely discharged!

11) The next ski can be charged when feeder has taken it's initial position in the charging.



**Risk of injury!**

If a malfunction should occur in the charging or discharging area that is caused by a jammed ski or board, the emergency stop key must be pressed before intervening.

### 9.2.4 Grinding a Rocker or V-Shape ski



In "V-Shape Rocker" mode you can grind skis up to a maximum width of 165 mm.

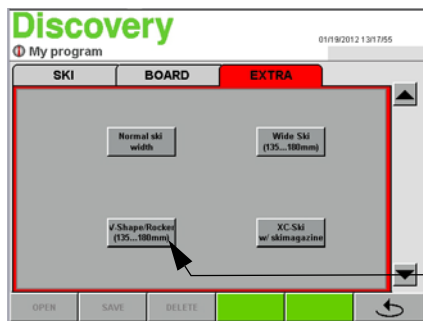

- 1) Select the "EXTRA" tab.
- 2) Select "V-Shape Rocker" [1].

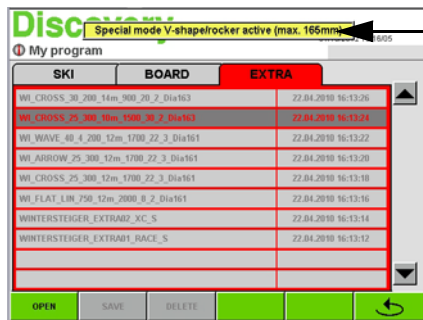

- 3) Select the required program ([see chapt. 8.1 Load grinding program, page 26](#)).



This operating mode is displayed in the upper screen section [2] while the mode is enabled!

4) Charge the ski magazine



**Ski stoppers have to be clamped up with an elastic band.**

**Take care that ski stoppers, which stick out compared to the ski, are 15 mm above base edge of the ski! Put the ski upside down into the ski magazine. The middle of the ski binding has to be at marking [A]. Ski tip must be on right side.**

5) Check if the discharging magazine is ready for charging skis.

- 6) Open desired program, adjust grinding angles for edge grinding processes if necessary.



**Reduce grinding force [1]**

**When grinding children skis, it is imperative to reduce the grinding force through the selection of the small arrow [1].**



**Risk of injury!**

**The ski magazine starts automatically. Therefore be careful when working in the charging area. Keep hands away during operation of ski magazine! Do not place or lean any objects on the ski magazine!**

- 7) Then press button "Start working process".



**Risk of injury!**

- 8) If a malfunction should occur in the charging or discharging area that is caused by a jammed ski or board, the emergency stop key must be pressed before intervening.

## 10 Change grinding program

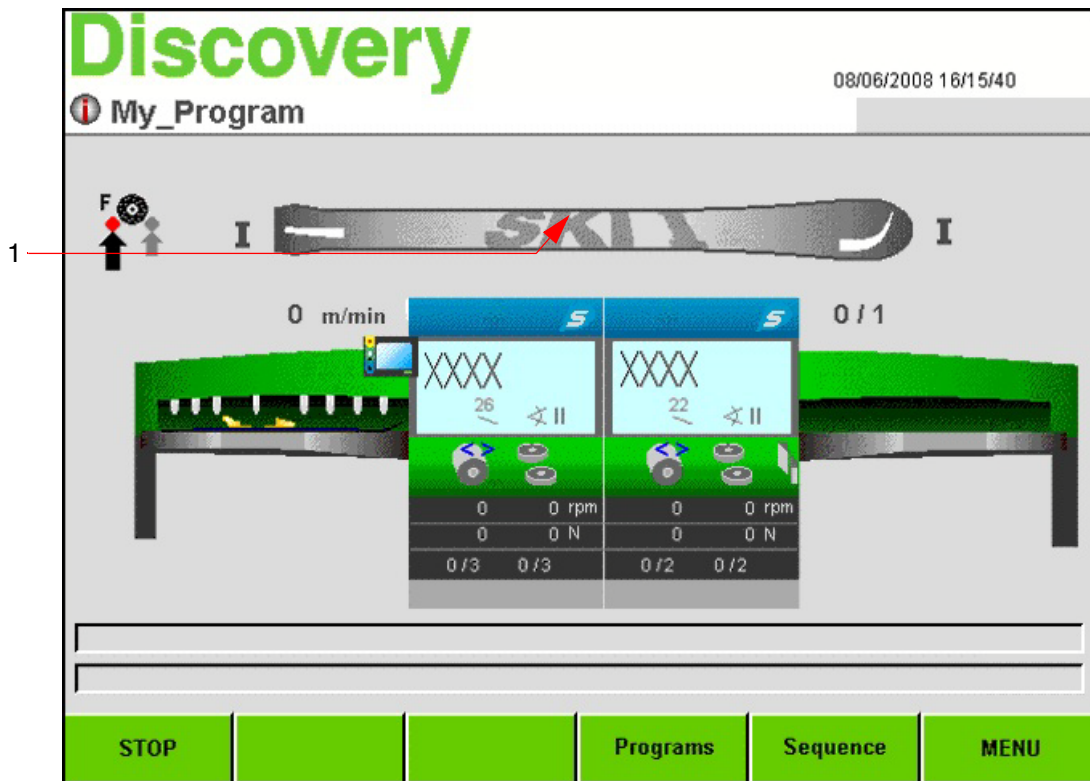

### 10.1 Automatic ski recognition

- The Discovery detects length, width and shape of ski and snowboards automatically. This is symbolically shown with the graphic [1].



When working without automatic ski recognition the ski or board type has to be selected manually by actuating the graphic [1].

| SKI                         | Board                         | EXTRA (Ski)          |
|-----------------------------|-------------------------------|----------------------|
| SKI 1 = All-round Ski       | Board 1 = 340mm - 300mm width | Extra 1 = RACE       |
| SKI 2 = Carving Ski         | Board 2 = 300mm - 270mm width | Extra 2 = XC         |
| SKI 3 = Extreme Carving Ski | Board 3 = 270mm - 240mm width | Extra 3 = customized |
|                             | Board 4 = 240mm - 210mm width |                      |



Take care of board width! The snowboard width is to be selected manually. Wrong selection can cause damages on the board or machine!

## 10.2 Tips for input fields



If the input field is actuated, a number block appears on the display, where you can enter the desired number. The value can be increased or decreased by pressing the arrow keys. Each input has to be confirmed with ENTER.

The screen can be left by pressing the key "↶" without changing the values. On the left top corner of the display the minimum and maximum input value is displayed.



### 10.3 Adjustment sequence of operations



Sequence of operations can be adjusted separately for each program.

- Load the program that should be changed
- Press key "Sequence" in the main screen
- The screen for sequence of operations is opened.

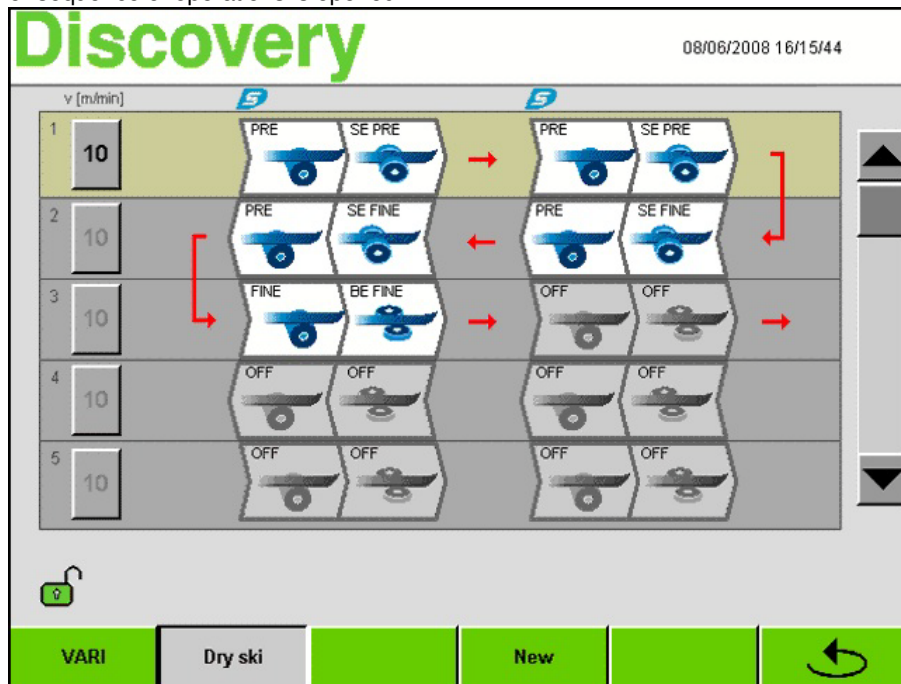

- Each processing step is shown symbolically. The processing direction of the ski/board is shown with the arrows.

#### Processing step according to example (screen above):

- 1) Stone pre-grinding (Module STONE 1) [⇨]
- 2) SE fine-grinding disc (Module STONE 1) [⇨]
- 3) Stone fine-grinding (Module STONE 2) [⇨]
- 4) BE fine-grinding Disc (Module STONE 2) [⇨]
- 5) Ski drying (Module STONE 2) [⇨]

#### 10.3.1 Selection of the processes

Following processes can be selected by actuating the symbols:

##### Module STONE [S]

- Stone pre-grinding (marked with PRE)
- Stone fine-grinding (marked with FINE)
- Stone unit deactivated (marked with OFF)
- Disc SE pre-grinding (marked with SE PRE)
- Disc SE fine-grinding (marked with SE FINE)

- Disc BE pre-grinding (marked with BE PRE)
- Disc BE fine-grinding (marked with BE FINE)
- Disc unit deactivated (marked with OFF)

### Ski drying

- The ski/board is dried after edge processing by actuating the key "Dry ski".



**Thirteen stone processes and SE/BE processes can be selected.**

### 10.3.2 Adjust feed speed

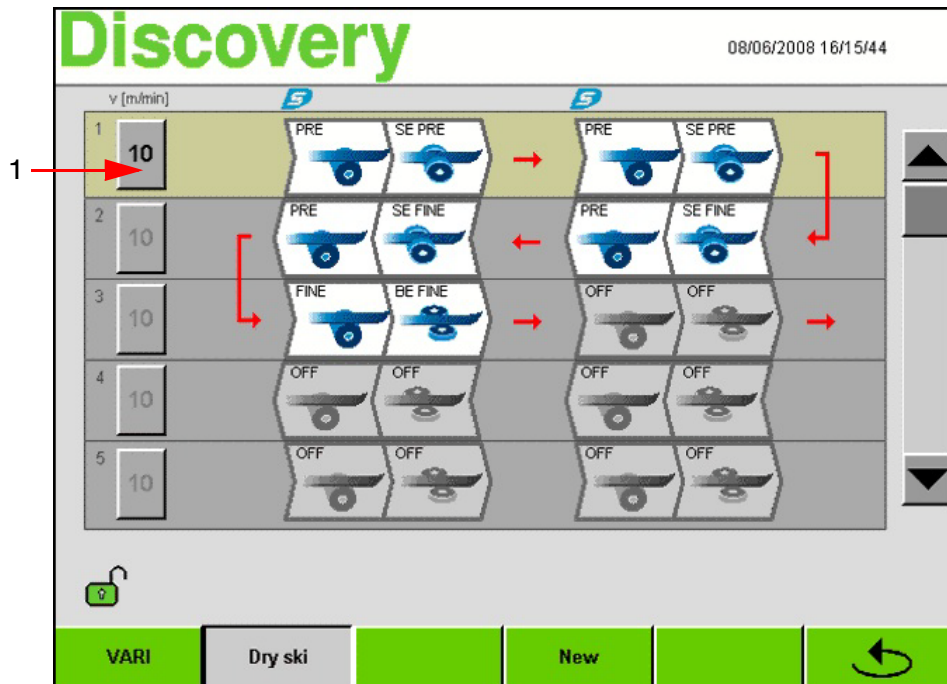

- By actuating the input field [1] the desired feed speed can be entered via the number block.
- Input area: between 3 and 15 m/min.

#### 10.3.2.1 Variable feed speed

- By actuating the key „VARI“ different feed speeds can be used for the separate lines.

#### 10.3.2.2 Delete the sequence of operations

- By actuating the key „New“ the whole sequence of operations is deleted.

### 10.3.2.3 Variable holding-down pressures with the snowboard programs

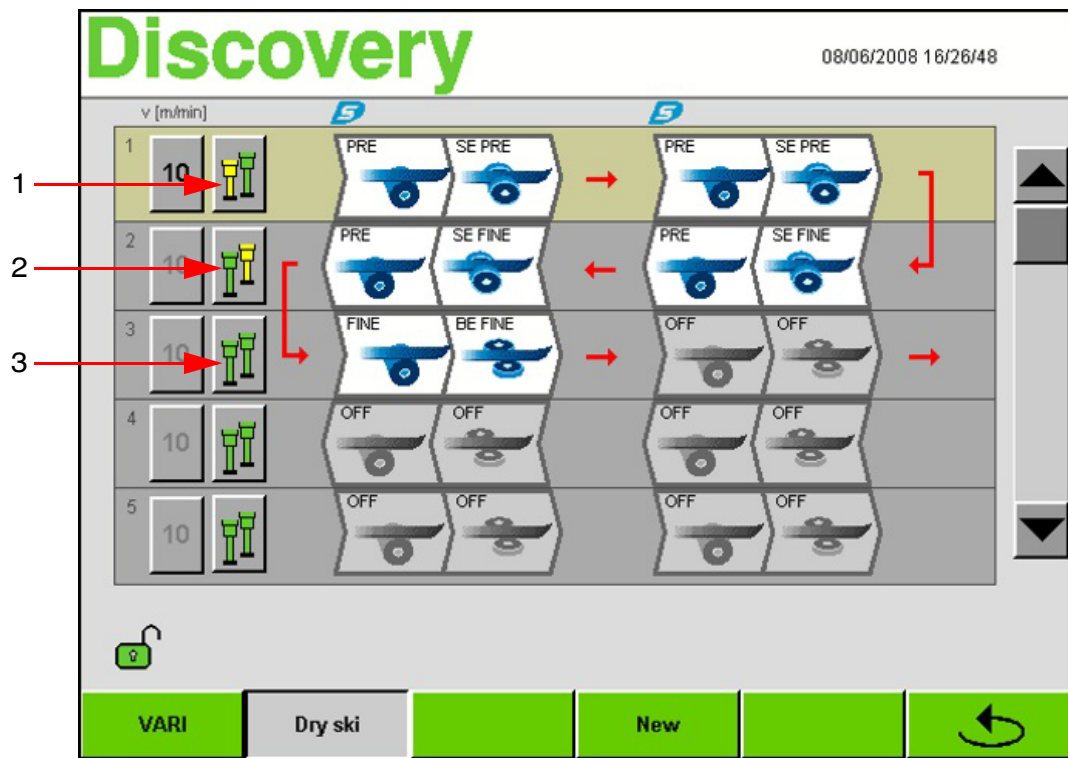

To enable an improved grinding with snowboards that are not plane, the holding-down pressures for each processing stage can be set differently and saved in the snowboard program.

- The holding-down pressure can be set for the front and the back by pressing the respective buttons.
- 1) Holding-down device, front => LOW (reduced pressure, displayed in yellow)  
Holding-down device, back => HIGH (standard holding-down pressure, displayed in green)
  - 2) Holding-down device, front => HIGH  
Holding-down device, back => LOW
  - 3) Holding-down device, front => HIGH  
Holding-down device, back => HIGH

## 10.4 Stone unit - change parameters

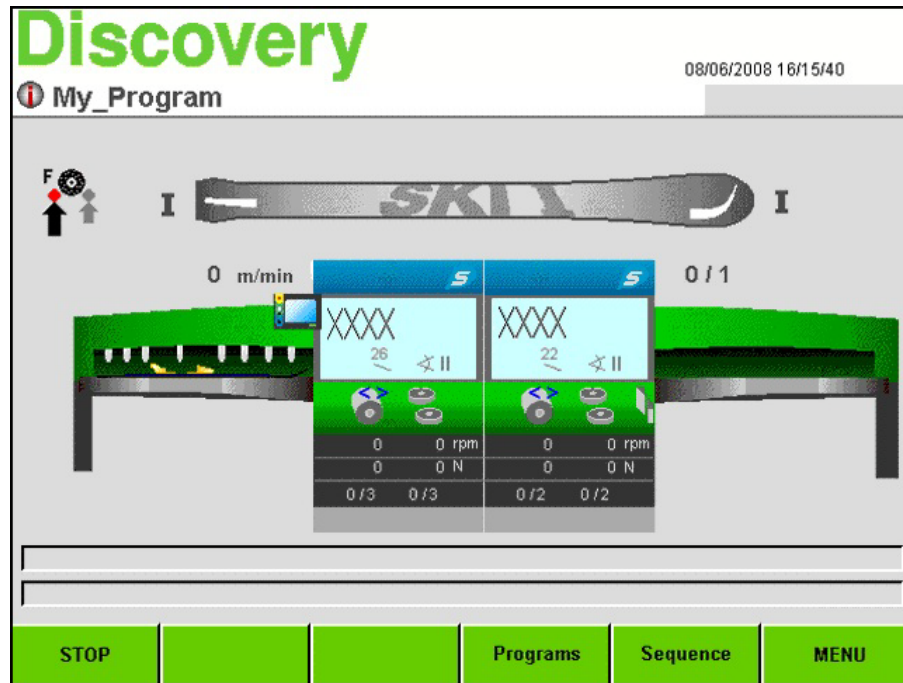

**i** The most important parameters are shown on the main screen on the graphic of the module STONE during operation.

- Kind of structure
- Dressing speed
- Angle adjustment disc
- Grinding rpm stone/disc
- Grinding force stone/disc
- Processes stone/disc (x of y)

### 10.4.1 Reduce grinding force for children ski

- Select between normal and reduced grinding force by pressing the arrow [A] on the main screen.
  - Small arrow -> low grinding force
  - Large arrow -> normal grinding force

**!** It is imperative that the grinding force is reduced to avoid damages to the children ski!

## 10.4.2 Speed parameters

- By touching the graphics of the respective module STONE on the main screen, the menu of the module parameters is opened.

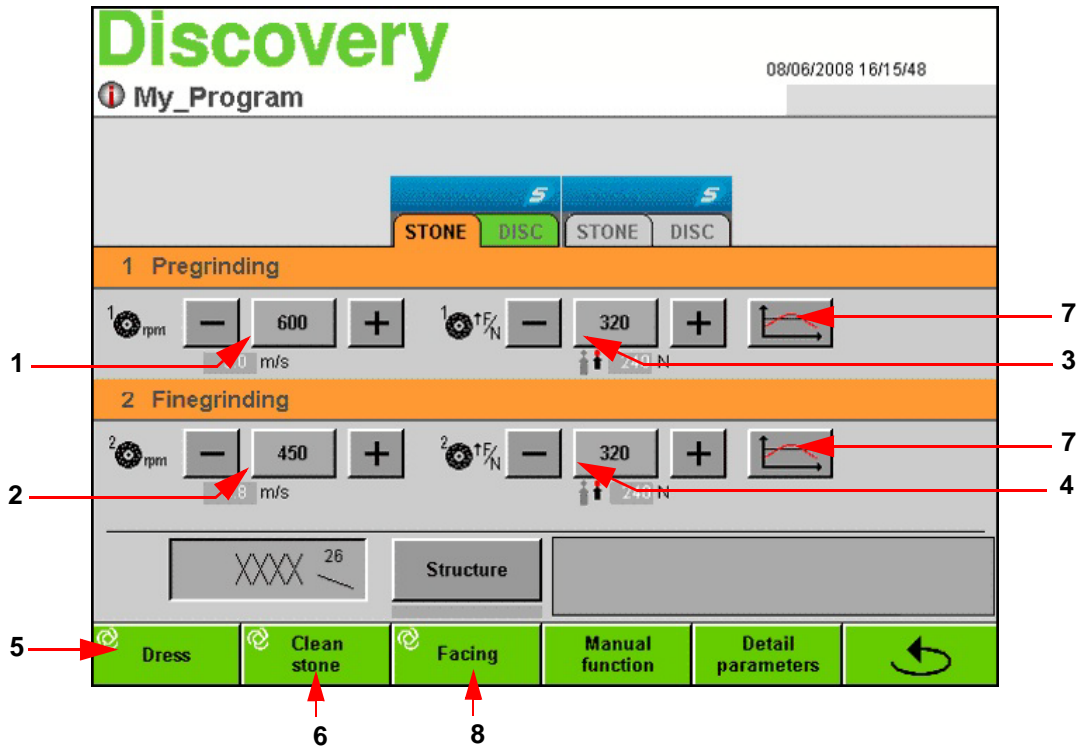

- Actuate the register "STONE" to call up the stone parameters.

### Pre-grinding speed [1]

- Actuate the field "Pre-grinding speed" [1]. Enter the desired speed with the number block and confirm with "ENTER". The field below shows the cutting speed in meters per second [m/s].

### Grinding force pre-grinding [3]

- Base force (in N) for the stone pre-grinding can be entered by actuating the field [3].

### Fine-grinding speed [2]

- Actuate the field "Fine-grinding speed" [2]. Enter the desired speed with the number block and confirm with "ENTER". The field below shows the cutting speed in meters per second [m/s].

### Grinding force fine-grinding [4]

- Base force (in N) for the stone fine-grinding can be entered by actuating the field [4].



The values can also be raised or reduced by actuating the keys +/-.

### Stone dressing [5]

- By actuating the key "Dress" the stone is dressed with the preset parameters.

**Stone cleaning [6]**

- As long as the key "Clean stone" is pressed, the stone is cleaned with the stone cleaner.



After stone dressing the cleaning process is carried out automatically!

**Variable grinding pressure [7]**

- [see chapt. 11 Variable grinding force, page 64](#)

**Stone facing [8]**

- By actuating the key "Facing" the stone is faced with a fine cross structure. This guarantees the same start situation for every applied structure.

**10.4.2.1 Detail parameters stone unit**

- By actuating the key "Detail parameters" further stone parameters can be changed.

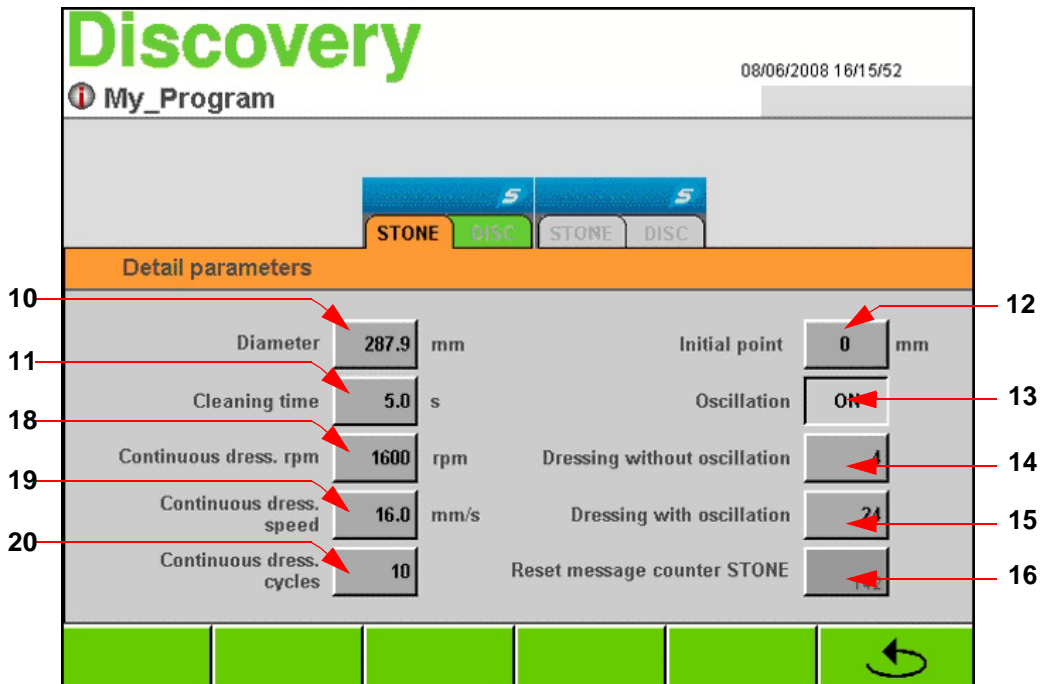

**Stone diameter [10]**

- [see chapt. 10.4.6 Check and adapt stone diameter, page 58](#)

**Cleaning time [11]**

- In this input field you can enter the stone cleaning period (0-9 sec.) after the dressing process (entering "0" deactivates the stone cleaner).



**Information for the continuous dressing**

During continuous dressing, ensure that the water cooling is sufficient. Maximum stone speed of 1300 – 1800 rpm. Dressing speed of approx. 18 – 23 mm/sec. If not observed, there is also a risk that the diamond will anneal out.

### Continuous dressing rpm [18]

- The stone speed (rpm) during continuous dressing is specified in this input field.

### Continuous dressing speed [19]

- The dressing speed during continuous dressing is specified in this input field.

### Continuous dressing moves [20]

- The number of dressing procedures during continuous dressing is specified in this input field.

### Initial point grinding stone [12]

- This function allows variation of initial points for grinding eg. for rental skis.
- By entering in the field „Initial point“ eg. +20, the stone unit sets in 20 mm in front of the set start position and sets off 20 mm behind the set end position.



**Adjustment area is between +50 and -100 mm. For negative values enter first the number, then the minus.**

### Oscillation [13]

- Selection of oscillating or non-oscillating stone. Use e.g. for straight structure.



**The stone is dressed automatically from time to time to avoid groove formation in the stone by the steel edges.**

### Dressing cycles without stone oscillation [14]

- The stone is dressed after the input number of processes was reached, with adjustment [Oscillation off].



**Not enough dressing cycles may cause groove formation on the stone, eg.: for middle-related structures as arrow structure, arrow structure with indentation or wave structure.**

### Dressing cycles with stone oscillation [15]

- The stone is dressed after the input number of processes was reached with adjustment [Oscillation on].

By actuating the key " " this screen is left and the menu of stone parameters is opened again.

### Reset message counter STONE [16]

- The message counter is to be reset after stone changing by actuating the key [16].

After the message counter as reached a preset number of messages, a moving message orders you to check or change the grinding stone or diamond. The counter is reset to "0" by actuating the moving message or by actuating the key "Reset message counter" [16].



10.4.3 Structure selection

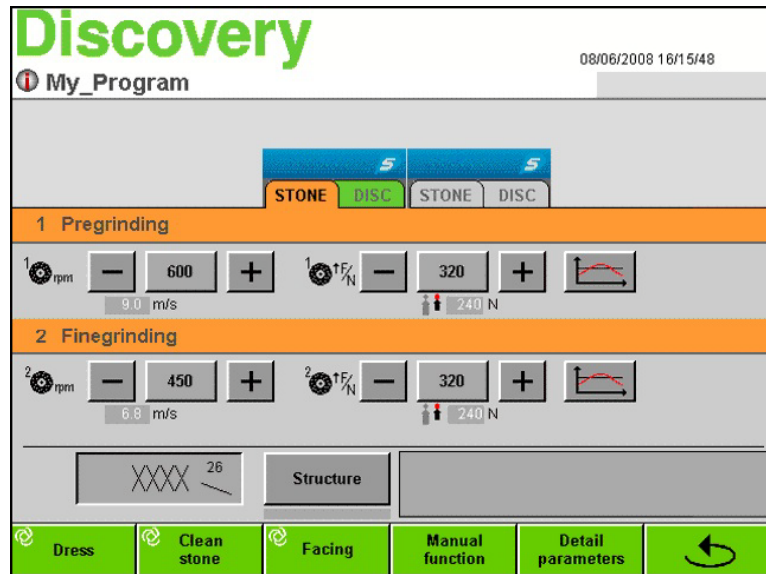

- The screen with the structure parameters is opened by actuating the key "Structure" in the window "Stone parameters".

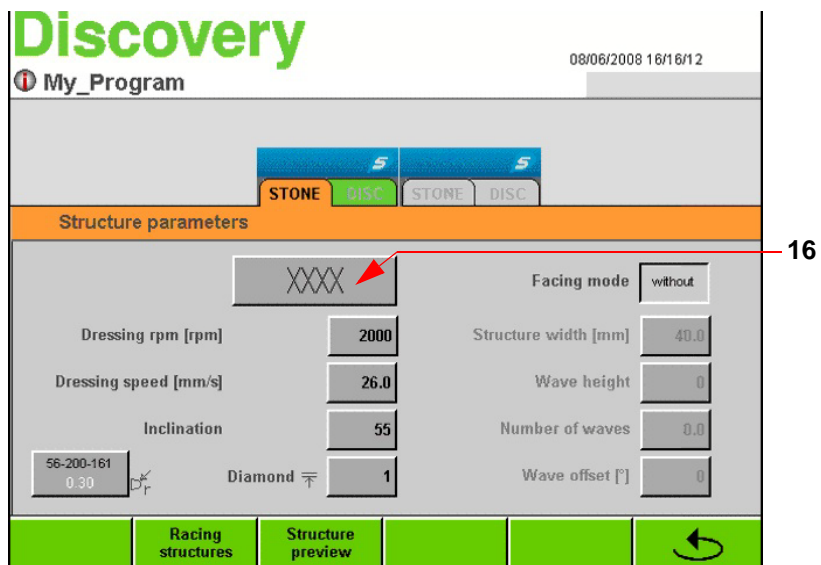

- By actuating the field "Structure" [16] another screen is opened where you can select the desired structure.

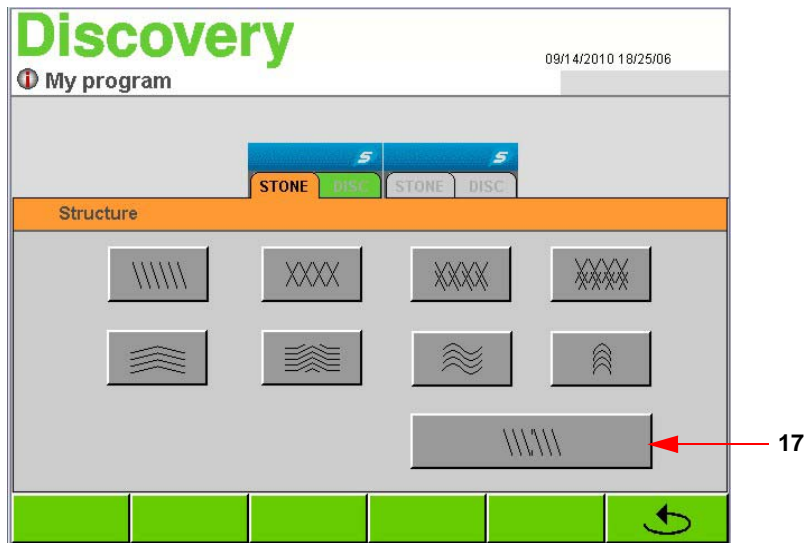

- By actuating the respective structure button the structure is adopted to the program.
- Adjustment of structure parameters [see chapt. 10.4.4 Structure parameters, page 50](#)
- Split structures can be selected by actuating the field [17].

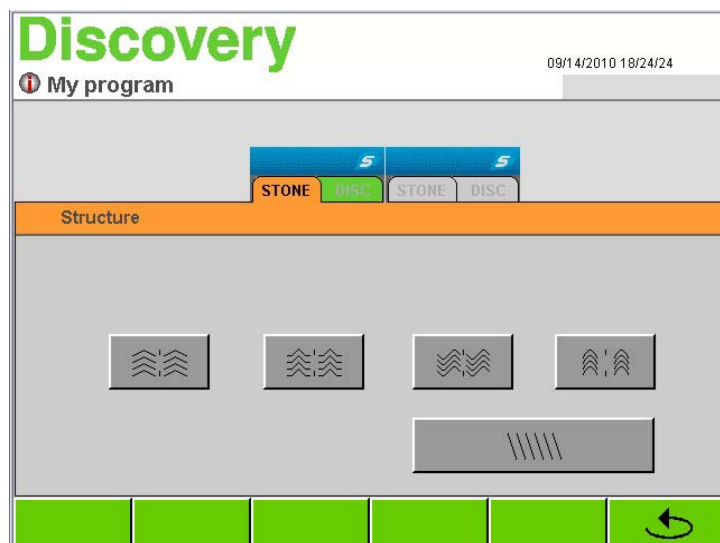

- V, arrow or wave structures are adjusted with split structures.
- The selected structure is applied to both sides of the stone. So that this structure is available for front and back feed system.
- Adjustment of structure parameters [see chapt. 10.4.4 Structure parameters, page 50](#)
- By actuating the respective structure button the structure is adopted to the program.

#### 10.4.4 Structure parameters

Following parameters can be adjusted after selection of the desired structure.

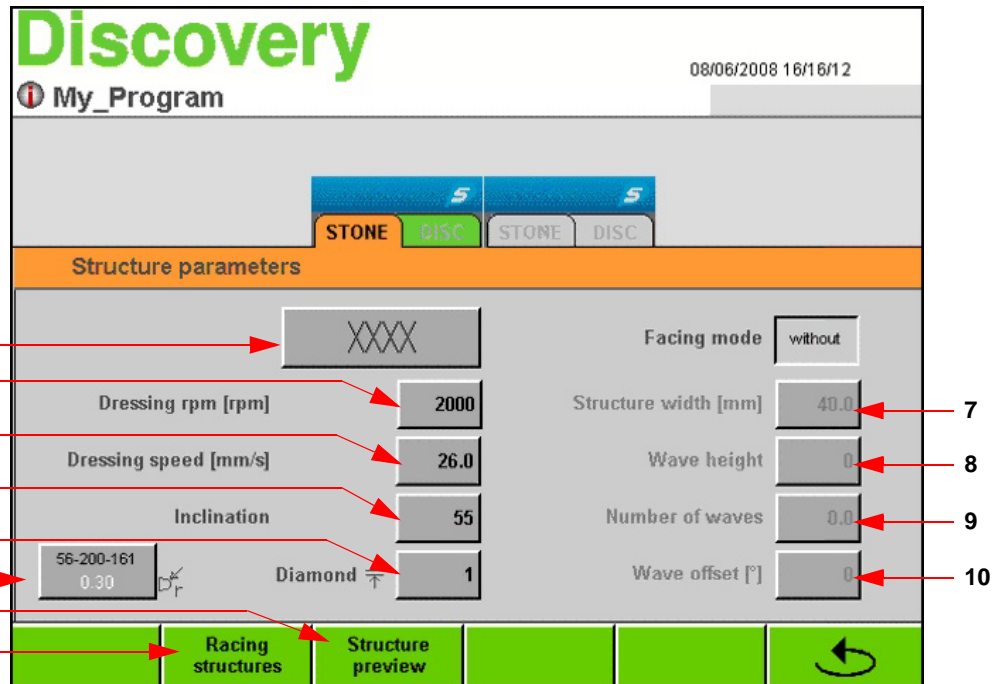

**Structure [1]**

- The selected structure is shown in the field "Structure".

**Dressing rpm [2]**

- The speed of the grinding stone during dressing process is entered in the field "Dressing rpm".

Adjustment area is between 600 and 2000 rpm.

**Dressing speed [3]**

- The speed of the dressing diamond is entered in the field "Dressing speed".

Adjustment area is between 3 and 35 mm/s.

**Structure inclination [4]**

- Structure inclination of the selected structure (except linear structure and wave structure) can be entered by actuating this field.

for example

- Value higher than 60: steeper structure
- Value lower than 60: flatter structure
- Value 0: straight-crossed structure



**This value is not indicated in degrees!**

**Structure depth (diamond feed) [5]**

- The structure depth can be entered in feed steps 1 - 3 by actuating the field "Diamond feed".  
1 feed step has a depth of 0.02 mm.

### Diamond selection [6]

- The diamond type that is used must be selected in order to attain agreement between the structure preview and the actual grinding pattern on the ski.

### Structure width [7]

**i** This parameter can only be adjusted for V-structure with indentation!

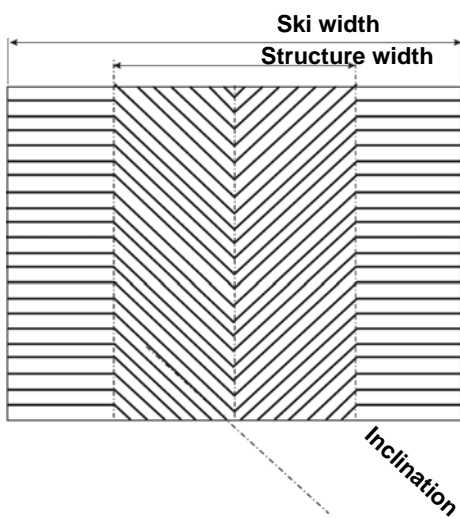

- The structure width means the width of the V - see drawing.

**i** Depending on input of inclination - positive or negative value, the structure changes to V or arrow structure.

**i** Following parameters can only be adjusted for wave structure!

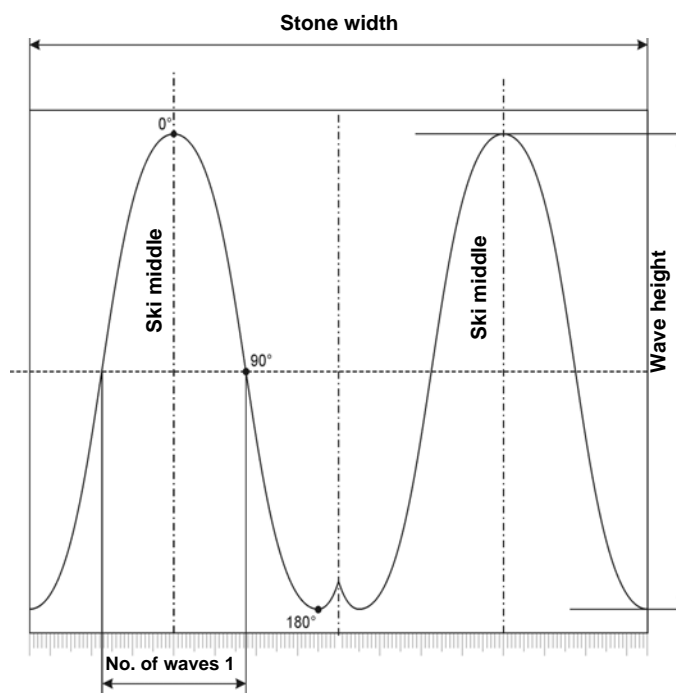

**Wave height [8]**

- The wave height can be entered by actuating the key "Wave height". A negative value e.g. -100 reflects the wave around the horizontal axis.



The wave height also depends on the feed speed and the grinding rpm.

**Number of waves [9]**

- The number of waves over the ski width can be entered by actuating the field "Number of waves".

**Wave position [10]**

- Wave position can be changed by actuating the field „Wave offset“.

e.g.: With an input of 0° the maximum of the wave is situated in the middle of the structure. With an input of 180° the minimum of the wave is in the middle of the structure. When entering a „Wave offset“ the structure on the stone gets asymmetric.



Dressing rpm, dressing speed and inclination have to be set for both, left and right stone half, when working with split structures.

**10.4.4.1 Chevron structure**

The screenshot shows the 'Discovery' control interface. At the top, it says 'Discovery' and '09/14/2010 18/26/07'. Below that is 'My program'. There are two sets of 'STONE' and 'DISC' buttons. The 'Structure parameters' section is highlighted in orange and contains the following fields:

- Margin Dressing speed: 5.0 mm/s (indicated by a red arrow labeled '11')
- Dressing rpm [rpm]: 1700 (two fields)
- Dressing speed [mm/s]: 22.0 (two fields)
- Inclination: 45 (two fields)
- Diamond: 3
- Facing mode: always
- Structure width [mm]: 70.0
- Wave height: 120
- Number of waves: 1.0
- Wave offset [°]: -15

At the bottom, there are buttons for 'Racing structures', 'Structure preview', and a refresh icon.

### Margin dressing speed [11]

- For a chevron structure additionally the margin dressing speed [11] can be insertet. The input area is betwenn 3 and 30 mm/s. The smaller the insertet value, the finer and less visible is the structure in the margin area.

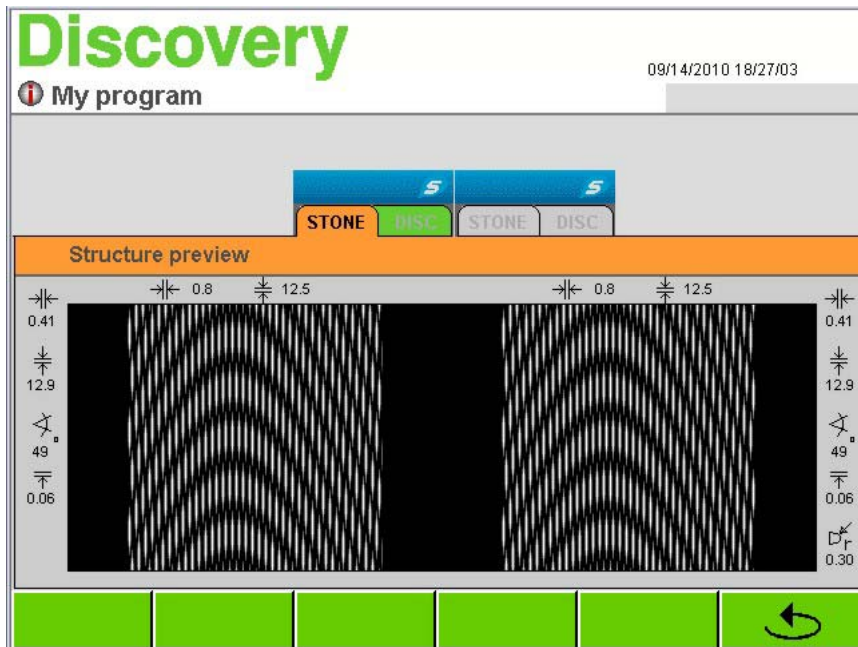



10.4.4.2 Racing structures

**i** Specific racing structures can be determined automatically based on the selection of snow/air temperature, type of snow, air humidity and discipline (Alpine and Nordic).

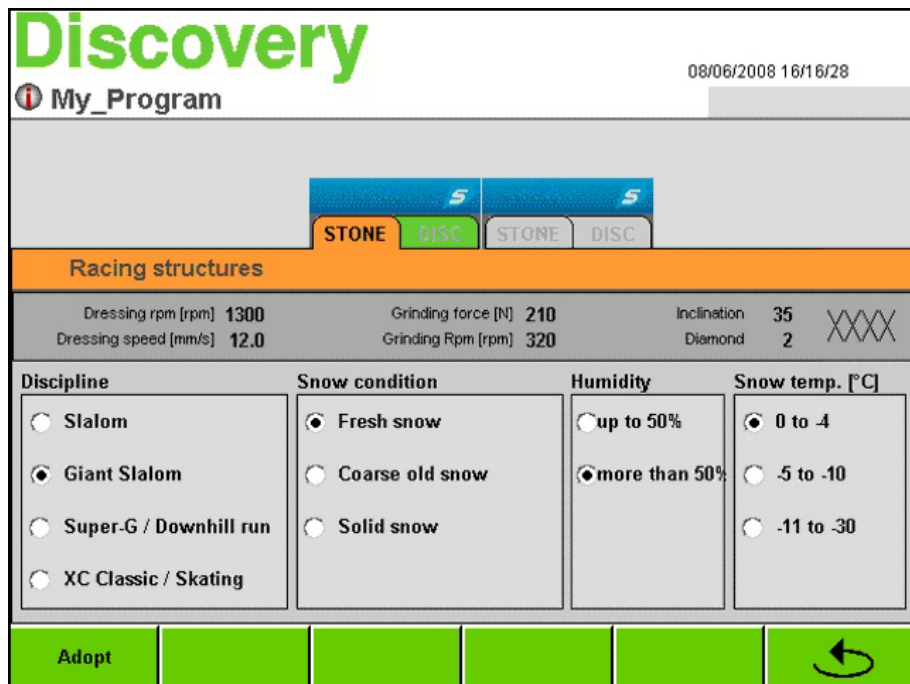
- The menu for racing structures is opened by actuating the key "Racing structure" [11] in the screen "Structure parameters".



- Select the desired parameters.
- The grinding parameters calculated by the program are shown in the top line.
- The parameters are adopted to the program location selected before by actuating the key "Adopt".
- By actuating the key " " this screen is left without adopting the grinding parameters.
- This symbol " " signalizes active racing structure.

**i** The symbol "Snowflake" is shown as long as you do not change any of the adopted racing parameters .

### 10.4.4.3 Structure preview

Most of the structures can be previewed.

- The structure preview is opened by actuating the key "Structure preview" [12] in the screen "Structure parameters".

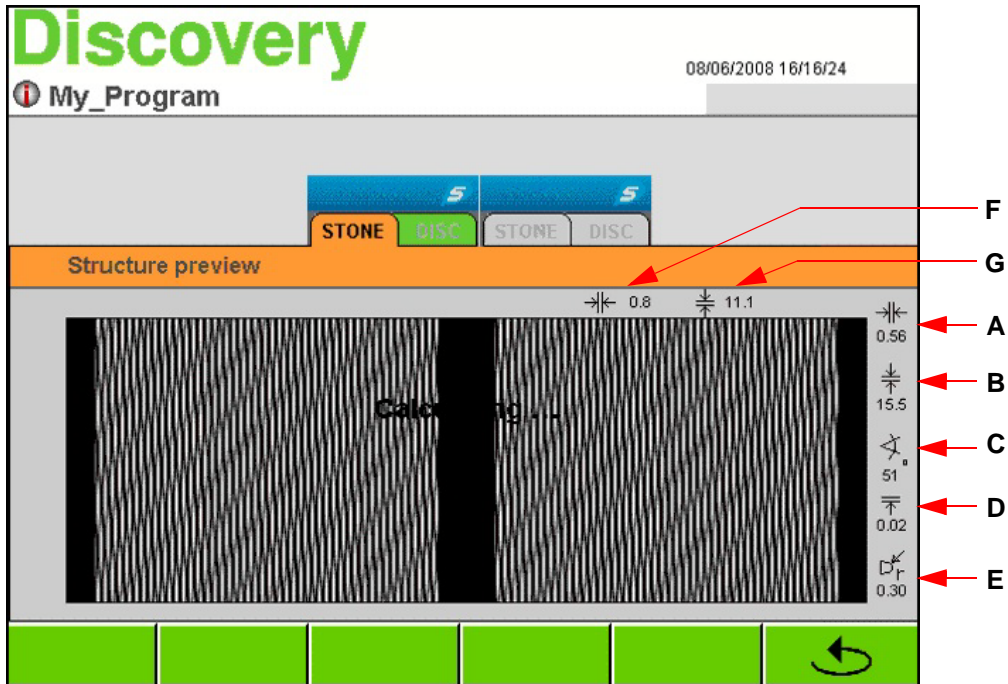

- The selected structure is graphically shown in this preview window.

Additionally the following structure information is shown:

- Groove width [A] in mm
- Groove length [B] in mm
- Structure inclination [C]
- Diamond feed [D] in mm
- Diamond radius [E] in mm
- Transverse shuttle distance [F] in mm
- Longitudinal shuttle distance [G] in mm



### 10.4.5 Manual functions stone unit

- The menu for manual functions of stone unit is opened by actuating the key "Manual functions" in the screen "Stone parameters".



This function can not be called up during grinding process!

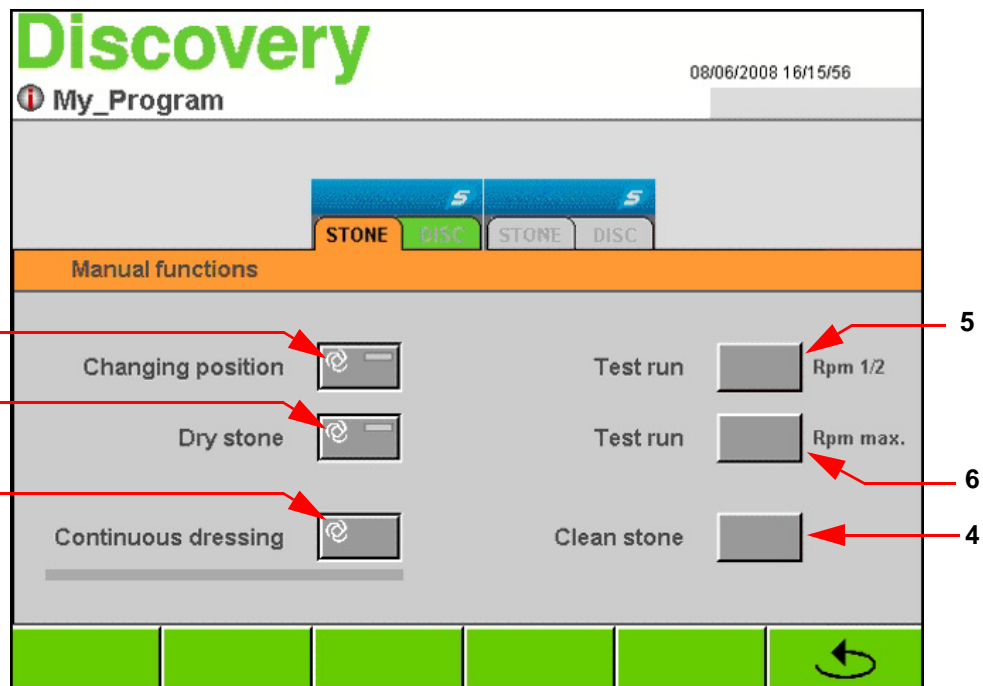

#### Changing position of stone [1]

- By actuating the key "Changing position", the stone unit and the diamond move to front position to guarantee optimum stone or diamond change.  
Stone changing - [see chapt. 14.2.1 Changing the grinding stone, page 86](#)  
Diamond changing - [see chapt. 14.2.2 Changing the diamond, page 87](#)

#### Drying grinding stone [2]

- The grinding stone should be spin-dried after it has not been used for longer periods or after cleaning the machine. The grinding stone is spin-dried with the preset parameters by pressing the button "Dry stone".
- e.g.: After cleaning the machine with the cleaning hose the grinding stone should be spin-dried by pressing this key (danger of unbalance).

#### Continuous dressing [3]

- The grinding stone is dressed with the parameters indicated in the "Detail parameters, stone" window by pressing the "Continuous dressing" button.

#### Clean stone [4]

- The stone is cleaned by the stone cleaner as long as the key "Clean stone" is pressed.

#### Test run rpm 1/2 [5]

- By actuating this key the stone motor is turned on/off with half speed 1000 rpm.

### Test run rpm max [6]

- By actuating this key the stone motor is turned on/off with maximum speed 2000 rpm.  
e.g. test run after stone changing.

### 10.4.6 Check and adapt stone diameter

**i** Because of the dressing cycles of the stone, the stone diameter decreases and therefore the swivel-in time and the grinding set-in point on the ski change. Generally the adjustment is performed automatically. However the screen "Pay attention to stone diameter" is shown automatically to check and eventually update the current stone diameter.

Stone diameter is to be corrected manually after following procedures:

- 1) Changing or resharpening the diamond
- 2) Changing the grinding stone
- 3) All work on the dressing unit of the stone slide

#### Input of the stone diameter

If the screen does not appear automatically, it can be opened with following steps:

- Actuate the graphics of the respective module STONE on the main screen.
- Actuate the register "STONE" to call up the stone parameters.

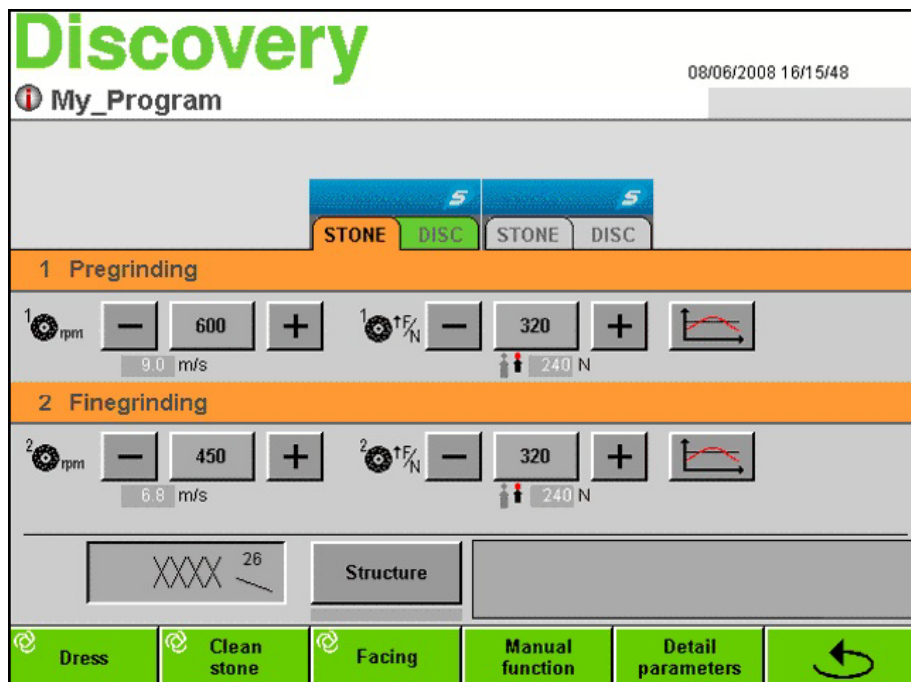

- The screen "Detail parameters" of the stone unit is opened by actuating the key "Detail parameters".

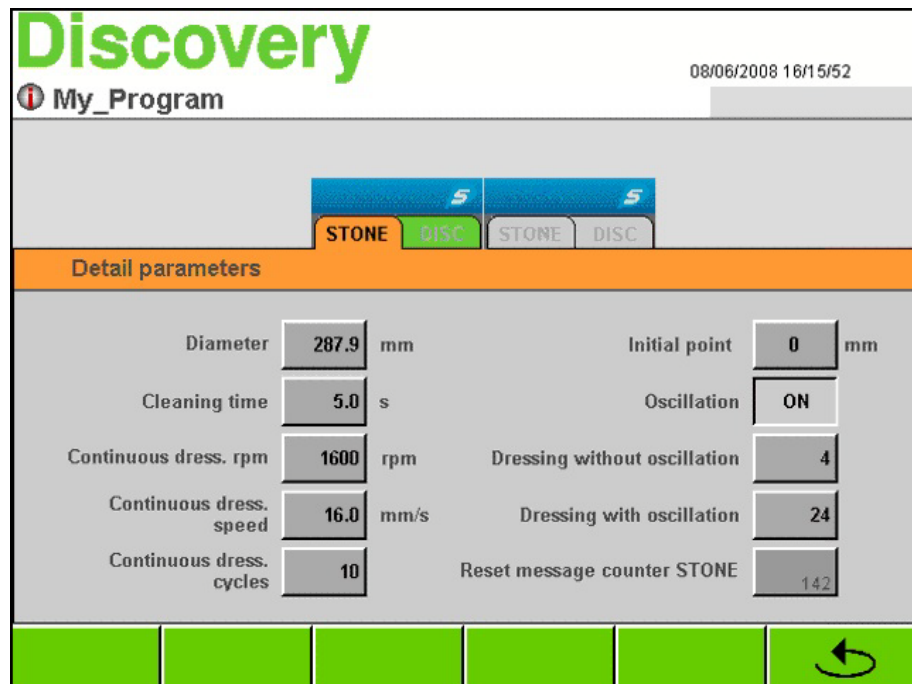

The stone diameter is shown in the field "Diameter". If this value (in mm) and the measured stone diameter do not match, the value has to be corrected.

- Actuate the field "Diameter".
- Enter the measured value (in mm) by the number block and confirm with "ENTER".

## 10.5 Disc unit - change parameters

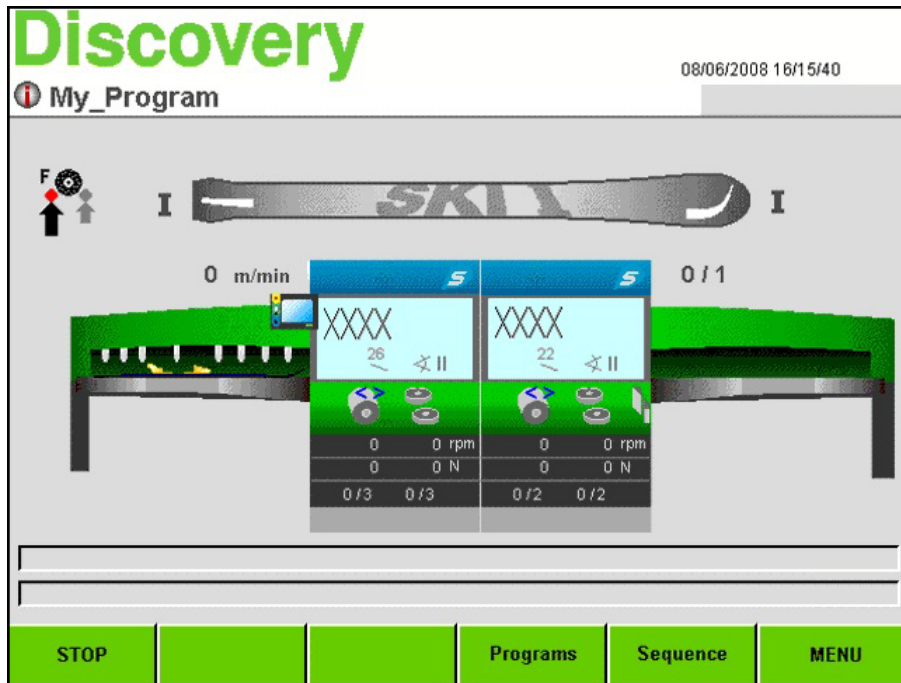

- By touching the graphics of the respective module STONE on the main screen, the menu of the module parameters is opened.

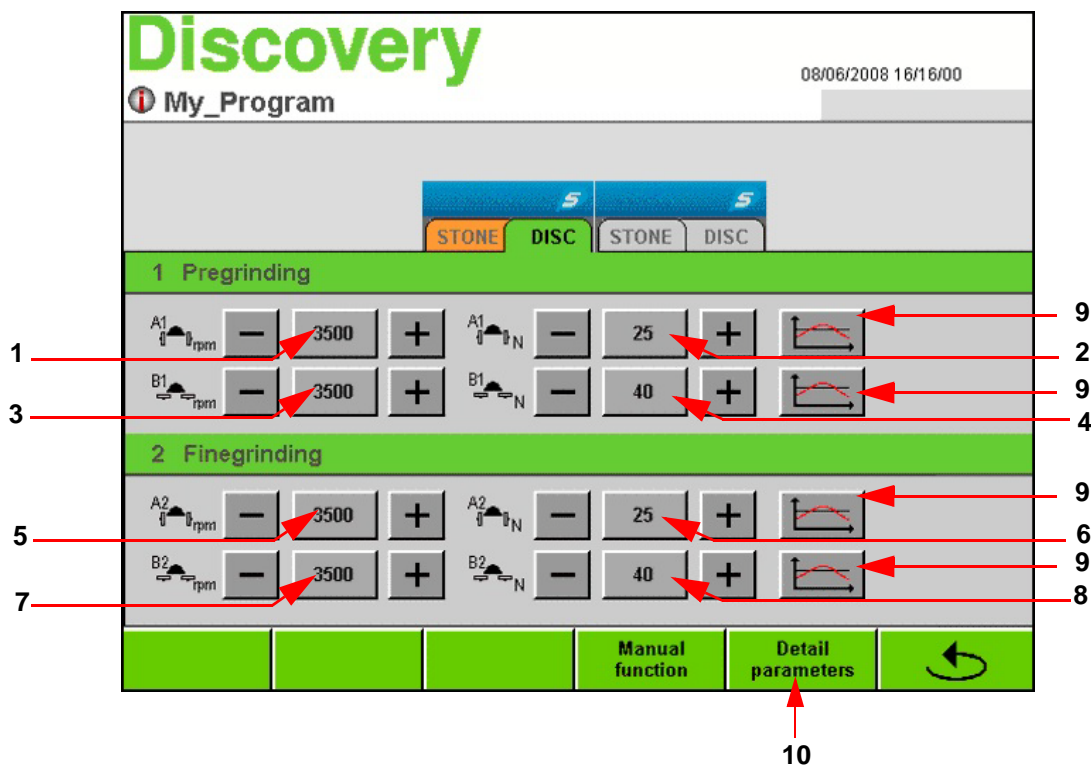

- Actuate the register "DISC" to call up the disc parameters.

### 10.5.1 Disc parameters

#### Pre-grinding speed SE [1]

- Actuate the field "Pre-grinding SE" [1]. Enter the desired speed with the number block and confirm with "ENTER".

#### Grinding force pre-grinding SE [2]

- Base force (in N) for the SE pre-grinding can be entered by actuating the field [2].

#### Pre-grinding speed BE [3]

- Actuate the field "Pre-grinding BE" [3]. Enter the desired speed with the number block and confirm with "ENTER".

#### Grinding force pre-grinding BE [4]

- Base force (in N) for the BE pre-grinding can be entered by actuating the field [4].

#### Fine-grinding speed SE [5]

- Actuate the field "Fine-grinding speed SE" [5]. Enter the desired speed with the number block and confirm with "ENTER".

#### Grinding force fine-grinding SE [6]

- Base force (in N) for the SE fine-grinding can be entered by actuating the field [6].

#### Fine-grinding speed BE [7]

- Actuate the field "Fine-grinding speed BE" [5]. Enter the desired speed with the number block and confirm with "ENTER".

#### Grinding force fine-grinding BE [8]

- Base force (in N) for the BE fine-grinding can be entered by actuating the field [8].



The values can also be raised or reduced by actuating the keys +/-.

#### Variable grinding pressure [9]

[see chapt. 11 Variable grinding force, page 64](#)

### 10.5.1.1 Detail parameters disc unit

- By actuating the key "Detail parameters" [10] further disc parameters can be changed.

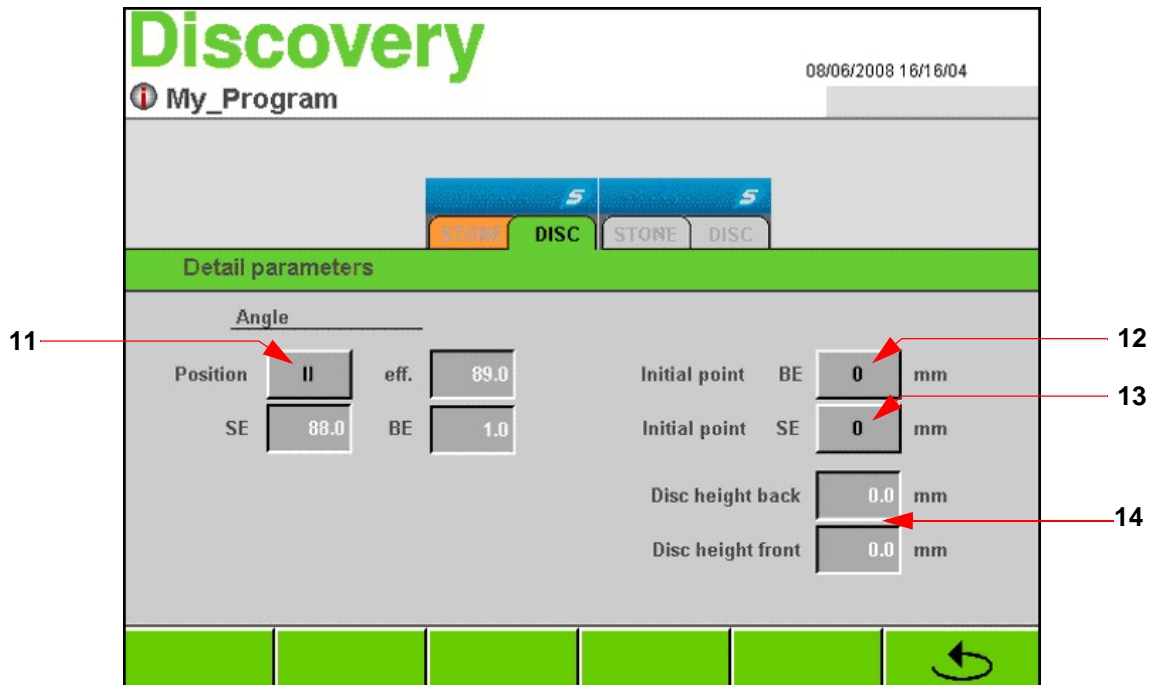

#### Position [11]

- By actuating the field "Position" four different angle adjustments can be selected. The grinding angle for base edge, side edge as well as the effective edge angle are shown above.

**i** This angle adjustment is only for information and is not adopted automatically to the disc unit. Actual grinding angle is to be adjusted manually ([see chapt. 6.3.1 Adjustment of the grinding angle disc. page 24](#)).

#### Initial point BE [12]

- This function allows variation of initial points for grinding eg. for rental skis.
- By entering in the field „Initial point BE“ eg. -50, the disc unit for base edge processing sets in 50 mm behind the set start position and sets off 50 mm in front of the set end position.

#### Initial point SE [13]

- By entering in the field „Initial point SE“ eg. +20, the disc unit for side edge processing sets in 20 mm in front of the set start position and sets off 20 mm behind the set end position.

**i** Adjustment area is between +50 and -100 mm for both parameters. For negative values enter first the number, then the minus.

#### Abrasion control discs [14]

- These two output fields show the current width of the front and rear disc. You will be informed by a message on the screen when the discs are nearly used up.

## 10.5.2 Manual functions disc unit

- The menu for manual functions of the disc unit is opened by actuating the key "Manual functions" in the screen "Parameters DISC".



This function can not be called up during grinding process!

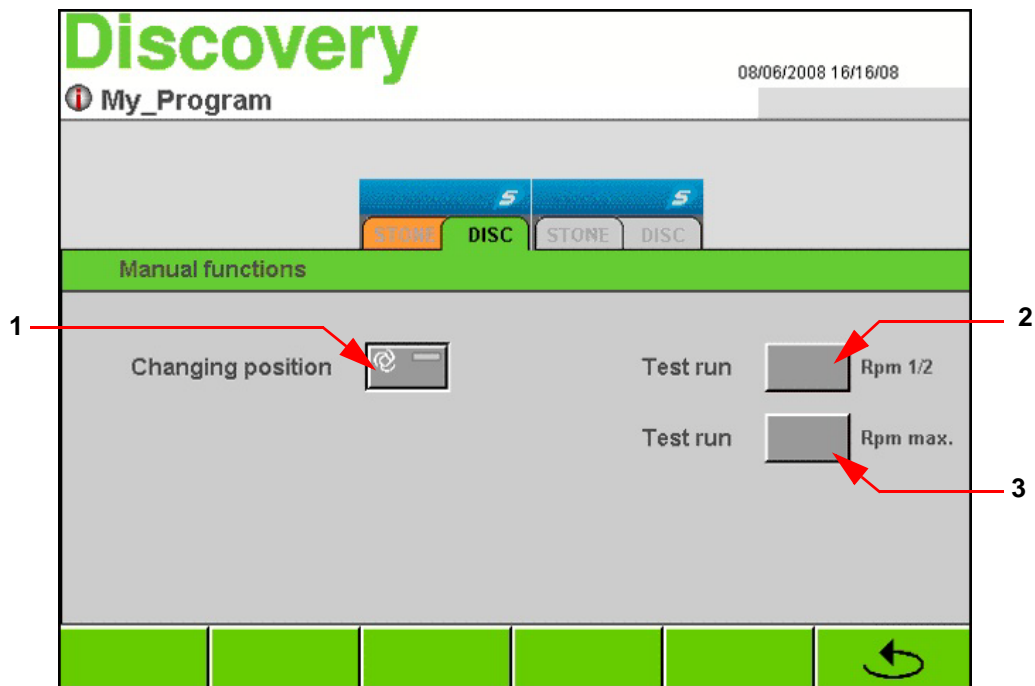

### Changing position of disc [1]

- By actuating the key "Changing position", the disc units moves to front position BE grinding to guarantee optimum disc change - [see chapt. 14.2.3 Changing the ceramic discs, page 88.](#)

### Test run rpm 1/2 [2]

- By actuating this key the disc motors are turned on/off with half speed 2250 rpm.

### Test run rpm max [3]

- By actuating this key the disc motors are turned on/off with maximum speed 4500 rpm.  
e.g. test run after disc changing.

## 11 Variable grinding force

To guarantee an optimum abrasion of the base at heavy fitted skis, the skis have to be ground partially with increased grinding force at the ski tip and ski end. For edge processing in the ski tip and ski end area a diminished grinding force will be an advantage.

**i** Adjusting the variable grinding force is the same procedure for all units. Following example describes the variable grinding force adjustment for the stone pre-grinding ski.

- eg.: open window "Stone parameters"

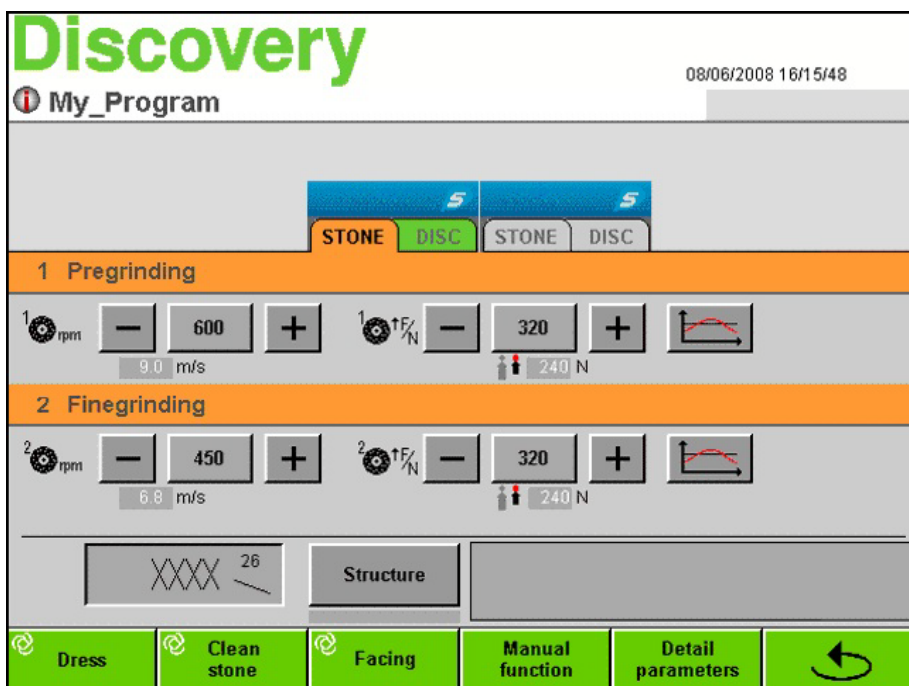



- Open the respective Servo menu by actuating the key "".

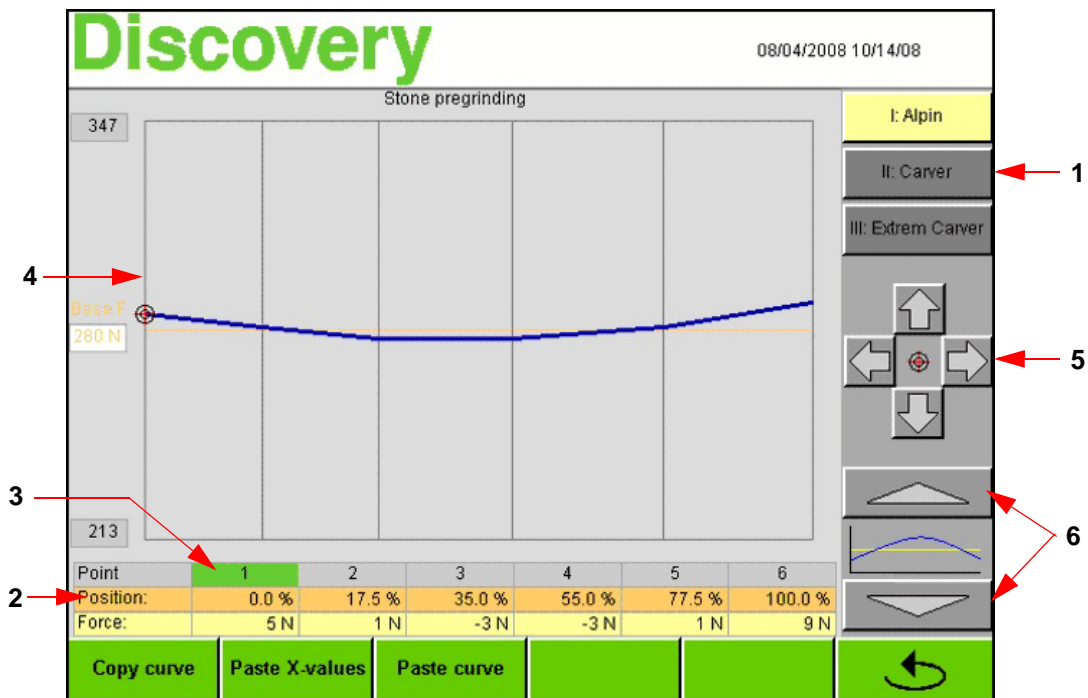

## 11.1 Changing the grinding force parameters

The grinding force and its areas can be set over the whole ski/board length. 3 pressure curves can be adjusted for every working process (eg. stone pre-grinding). These 3 pressure curves can be adapted according to ski or snowboard type.

- Actuate the respective key [1] to set the pressure curve for alpine skis, carving skis or extreme carving skis.
- 6 points [6] are set over the whole ski/board length. The ski/board length is shown in percentage (0% = ski end, 100% = ski tip).
- By actuating one of the keys 1, 2, 3, 4, 5 or 6, its color turns to green and the position in the curve is marked [4].
- The selected set point can be changed (starting with the preset base force) by the cursor keys [5].
- The horizontal position of the selected set point can also be changed by actuating the cursor keys [5].
- The position of the whole curve (starting with the preset base force) can be changed by actuating the keys [6].

### 11.1.1 Copy - paste curve

- The whole curve can be copied to another working process (eg. SE pre-grinding) by actuating the key "Copy curve".
- Additionally the positions [2] can be pasted in another working process (without copying the grinding force) by actuating the key "Paste X values".

## 12 General adjustment

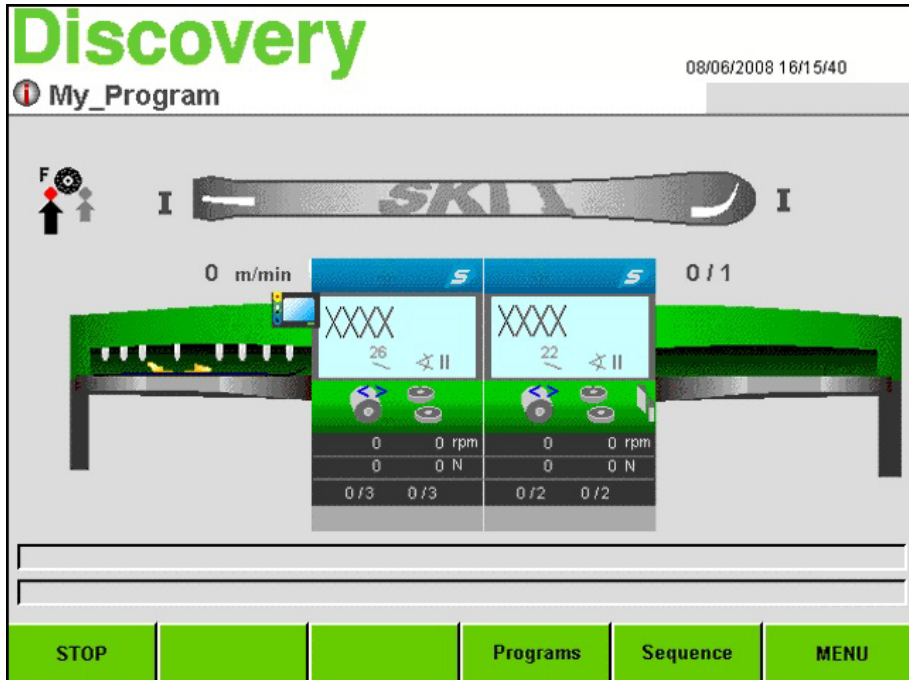

- Following screen is opened by actuating the key "Menu".

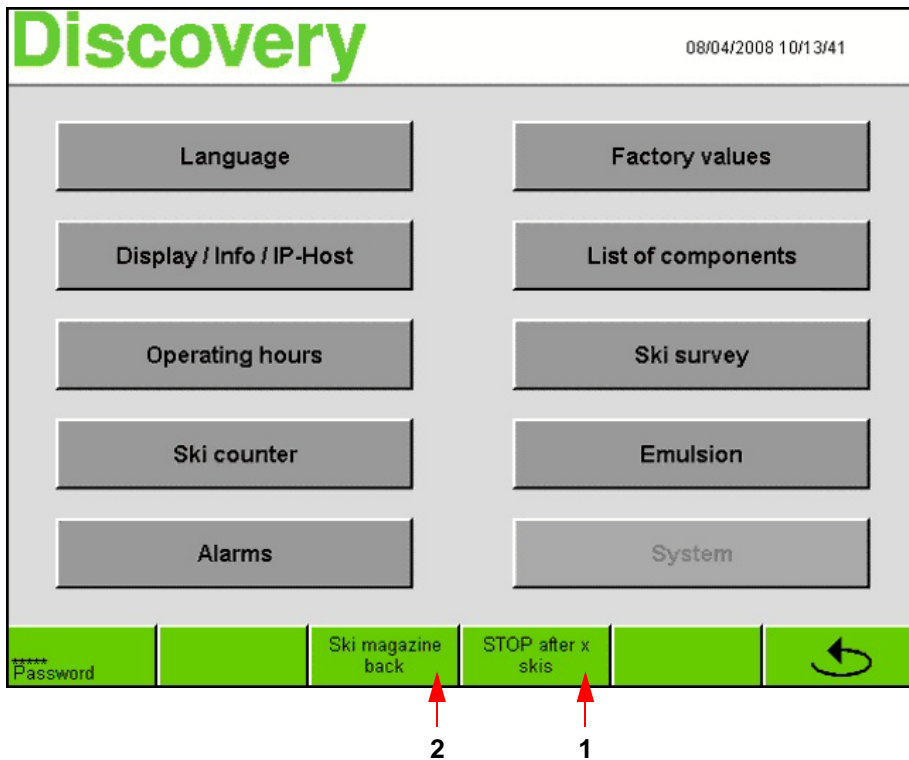

### 12.1 Stop after x skis

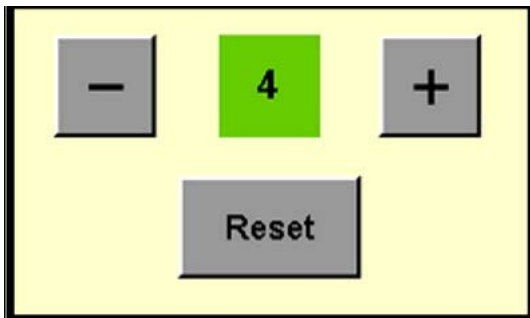

- An additional window is opened after pressing the button [1] "STOP after x skis".
- By pressing the +/- buttons, the number of skis can be entered until the machine is stopped.
- The input is activated by pressing the "↻" button and you then return to the main screen.
- The input is deleted by pressing the "Reset" button and the function is finished.



The number of skis up until the machine is stopped is displayed on the "STOP" button in the main screen.

### 12.2 Ski magazine return

By pressing the button [1] "Ski Magazine Return", the ski magazine cycles back by one ski when charging.

### 12.3 Language selection

- The menu for selecting the language is opened by actuating the key "Language".



- The whole menu-driven application is set to the desired language by touching the respective language.
- By actuating the key "↻" this screen is left and the "Menu" is opened again.

## 12.4 Change date, time and display brightness

- Following window is opened by actuating the key "Display/Info".

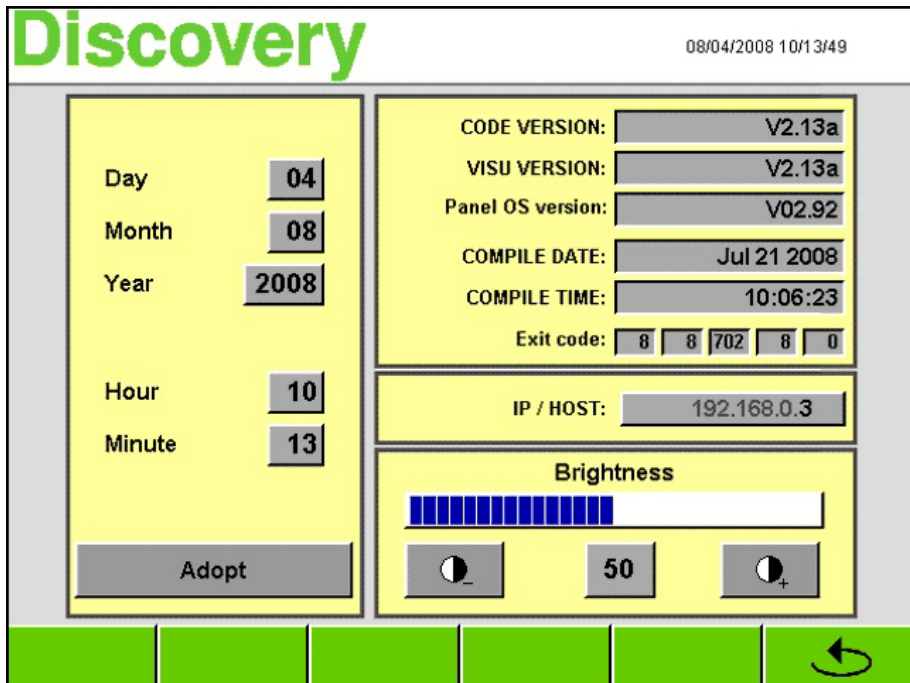

- Actuate the desired field.
- Enter the desired number via the number block and confirm with "ENTER".
- By actuating the key "Adopt" the adjustment is adopted to the system.
- Brightness of the display can be adjusted by actuating the respective keys +/-.
- By actuating the key " this screen is left and the "Menu" is opened again.

## 12.5 Operating hours

- Following window is opened by actuating the key "Operating hours".

Discovery
08/04/2008 10/13/53

|   |   |
|---|---|
| <p><b>FEED FRONT</b></p> <p>Main motor <input type="text" value="20 : 13 : 57"/></p> <p>Way [m] <input type="text" value="15804.0"/></p> <p>Motions <input type="text" value="4821"/></p>   | <p><b>PUMP</b></p> <p>Water pump 1 <input type="text" value="673 : 11 : 32"/></p> <p>Water pump 2 <input type="text" value="672 : 55 : 35"/></p> <p>Drain water pump <input type="text" value="135 : 01 : 06"/></p> |
| <p><b>FEED BACK</b></p> <p>Main motor <input type="text" value="387 : 58 : 45"/></p> <p>Way [m] <input type="text" value="272993.8"/></p> <p>Motions <input type="text" value="49161"/></p> | <p><b>FAN</b></p> <p>Drying fan <input type="text" value="619 : 18 : 52"/></p>  |
| <p><b>Ski counter</b></p> <p>SKI <input type="text" value="2155"/></p> <p>BOARD <input type="text" value="28"/></p> <p>EXTRA <input type="text" value="0"/></p>                             |   |

BELT
STONE 1
FINISH
 
↶

- All operating hours of the feed system, the pumps and fans are shown in this window. The operating hours of the available modules can be viewed by actuating the respective button "BELT", "STONE1" or "FINISH".

## 12.6 Ski/board counter

- Following window is opened by actuating the key "Ski counter".

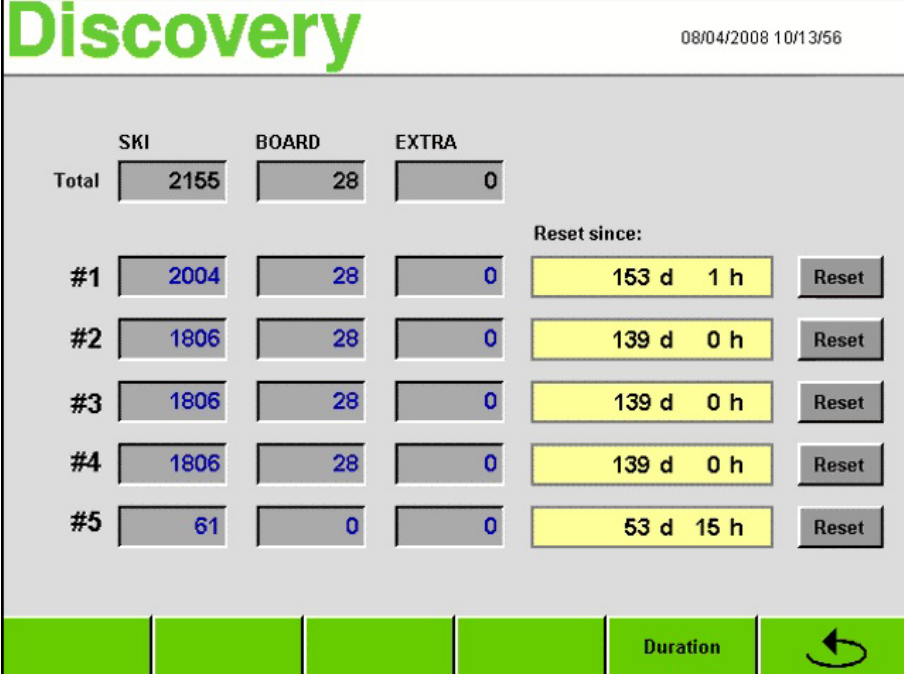

|       | SKI  | BOARD | EXTRA | Reset since: | Reset |
|-------|------|-------|-------|--------------|-------|
| Total | 2155 | 28    | 0     |              |       |
| #1    | 2004 | 28    | 0     | 153 d 1 h    | Reset |
| #2    | 1806 | 28    | 0     | 139 d 0 h    | Reset |
| #3    | 1806 | 28    | 0     | 139 d 0 h    | Reset |
| #4    | 1806 | 28    | 0     | 139 d 0 h    | Reset |
| #5    | 61   | 0     | 0     | 53 d 15 h    | Reset |

Duration 

### Total counter

- First line shows the total numbers of ground skis, boards or extras since first start up of the machine.

### Daily counter

- 5 daily counters can be managed for skis, boards or extras.  
eg. by actuating the key "RESET" in line "#1", the counter, date and time of counter 1 are reset to "0".
- By actuating the key "" this screen is left and the "Menu" is opened again.

## 12.7 Alarm history

- Actuate key „Alarms“ in the screen MENU.

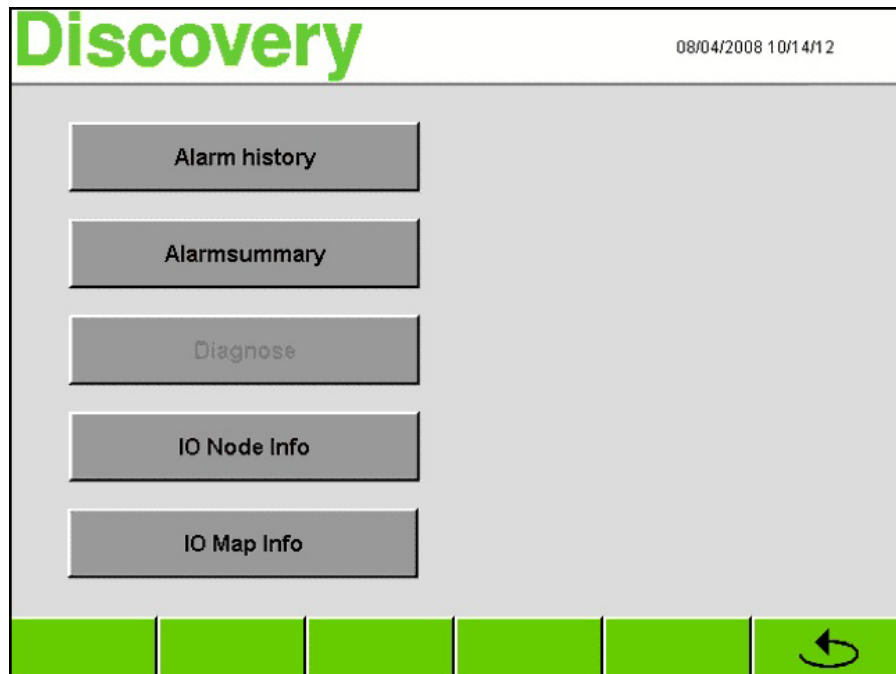

- Following screen is opened by actuating the key "Alarm history".

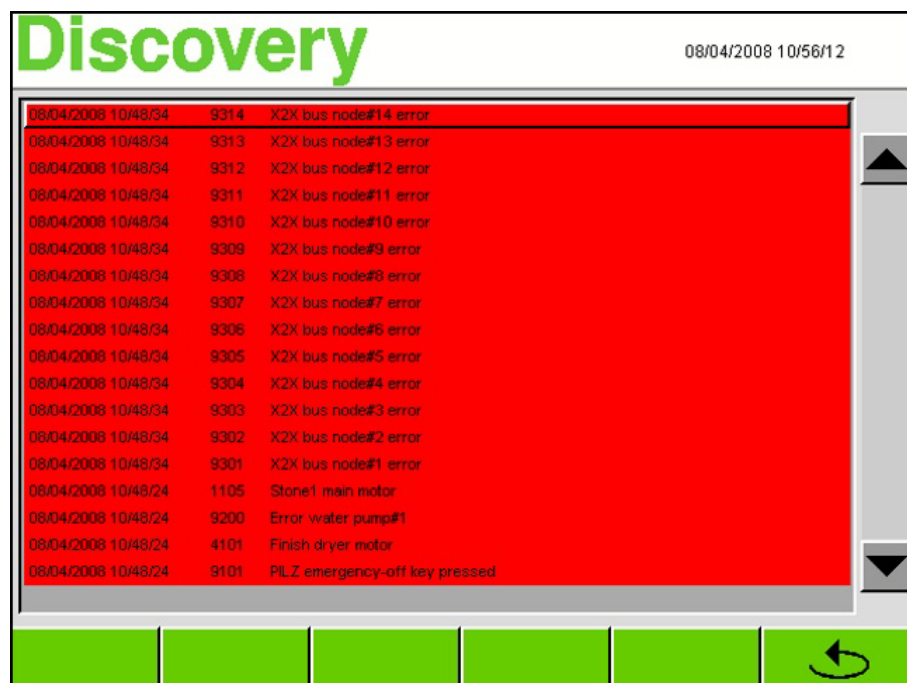

- This window shows all error messages since first start up of the machine.
- This message list can only be deleted by a WINTERSTEIGER Service Technician.
- By actuating the key "  " this screen is left and the "Menu" is opened again.

## 12.8 Factory values

- Following screen is opened by actuating the key "Factory values".

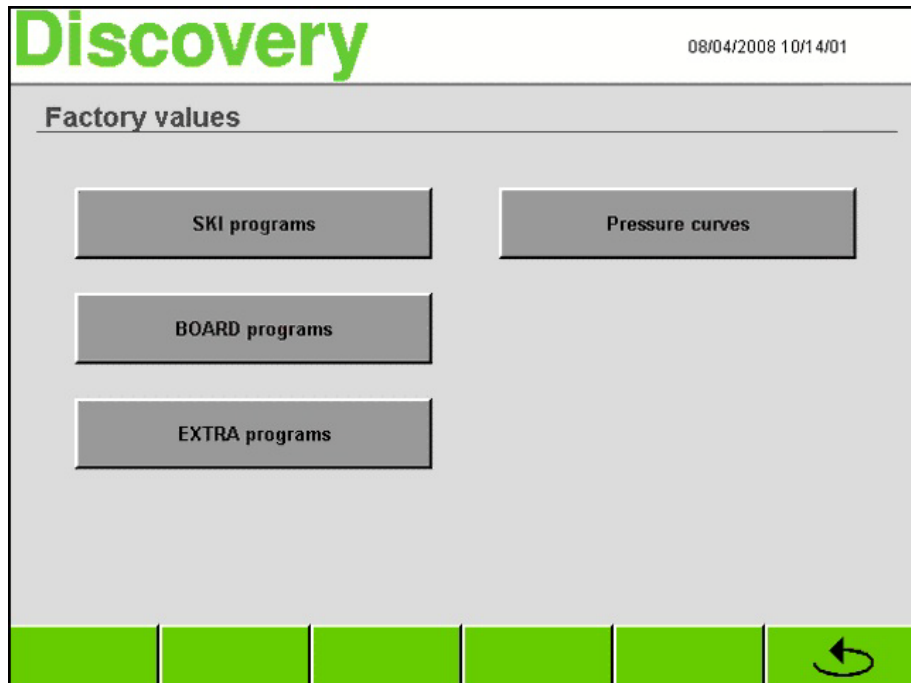

- The original WINTERSTEIGER programs for SKI, BOARD, EXTRA can be generated in this window.



**This is necessary, e.g. for module extensions or with a software update!**

### Pressure curve

- All pressure curves are reset to the preset WINTERSTEIGER values by actuating this key.
- By actuating the key " " this screen is left and the "Menu" is opened again.



## 12.9 List of components

- Following window is opened by actuating the key "List of components".

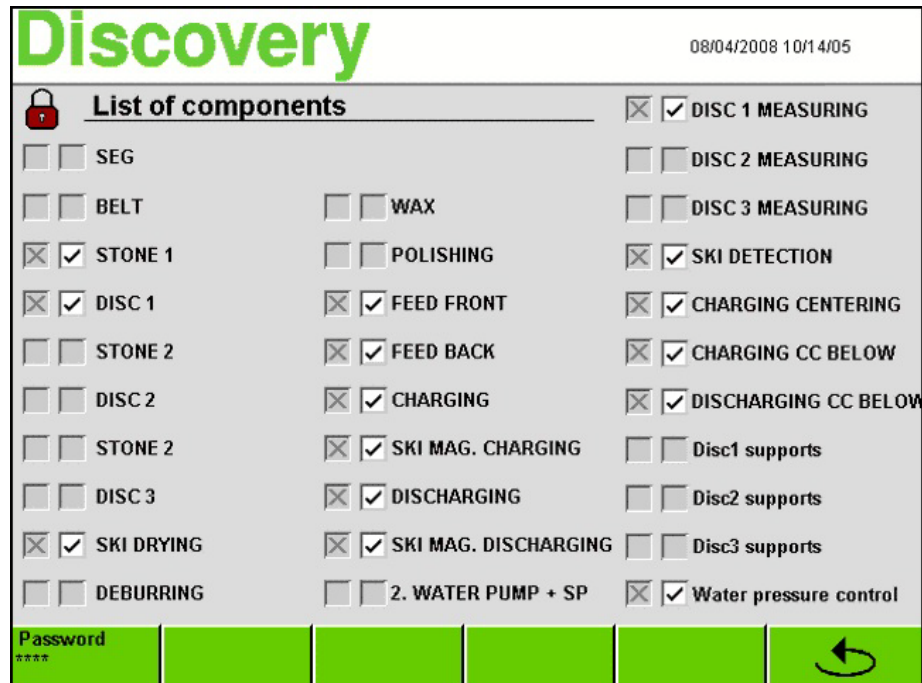

- All available components are marked with [X].
- In case of a failure, the respective unit can be deactivated.
- To avoid accidental deactivation of a component, a password has to be entered first.

### 12.9.1 Password for component list

- By actuating the key "Password" a number block opens
- Enter password: 7752
- After entering the password the lock on the top left is shown green.
- Now the respective component can be deactivated.



**A manually deactivated component is activated automatically with the next start-up of the machine (by actuating the main switch).**

- By actuating the key " " this screen is left and the "Menu" is opened again.

## 12.10 Ski measurements

- The following window will be opened by pressing the "Ski measurements" button in the "Menu" window.

The automatic ski model recognition is displayed in this window and is predominantly used by the WINTERSTEIGER service engineers for fault analysis.

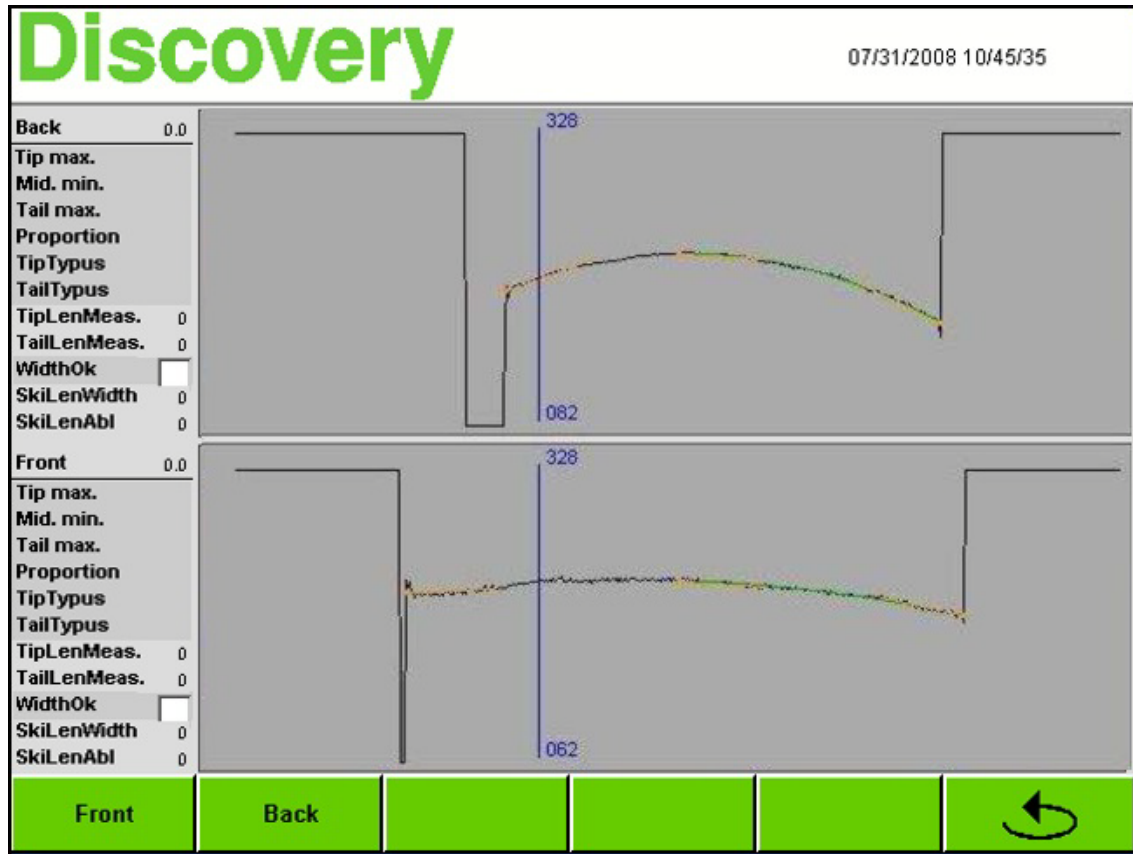

- Press the "" button to open the main screen.

## 12.11 Emulsion calculator

- The following window is opened by pressing the "Emulsion" button in the "Menu" window.

The emulsion calculator is used to calculate the correct mixing ratio for the emulsion.

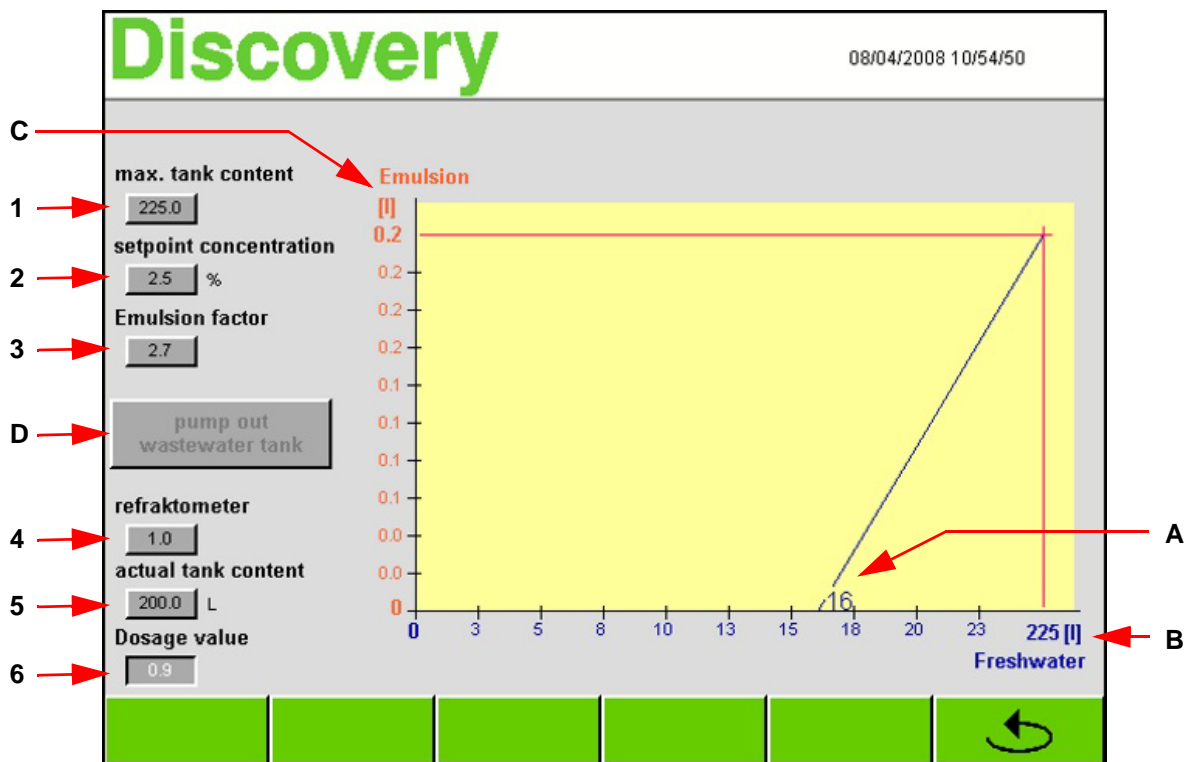

**i** Before the mixing ratio and the tank content can be measured, the machine has to have previously been switched off for at least 15 minutes to allow the residual water to drain into the tank to be able to obtain correct values using the emulsion calculator. Waste water tanks must be pumped empty by pressing the [D] button before the measurement is carried out.

**Max. tank content [1]**

- The maximum filling amount of the water tank is specified in this input field. The filling quantity is 450 or 225 liters, depending on the machine type.

**i** The values for the 225 liter tank apply for the following description!

**Setpoint concentration [2]**

- The emulsion/water mixing ratio is specified in this input field. The required mixing ratio can be seen on the corresponding emulsion container.

**Emulsion factor [3]**

- The emulsion factor for converting the actual mixing ratio using the value read with the refractometer is specified in this input field.

The required emulsion factor can be seen on the corresponding emulsion container or in the operating manual of the refractometer.

**Sample calculation**

- The measured value of the refrigerant on the refractometer is 1.0 and the filling amount is approx. 400 (200) liters depending on the machine type.
- Enter the value 1.0 in the "Refractometer value" input field [4].
- Enter 400 (200) liters in the "Actual tank content" input field [5].

**The following data can be seen in the emulsion diagram according to the example:**

- A: The optimum emulsion/water mixing ratio is provided again if the tank is topped off with 32 (16) liters of fresh water.
- B: The water tank is full again if the tank is topped off with 50 (25) liters of fresh water.
- C: If the tank is topped off with 50 (25) liters of fresh water, 0.4 (0.2) liters of emulsion must be added.

**Dosage value [6]**

If an emulsion mixing device with a dosing unit (order number 55-645-311) is available, set the displayed dosage value to 50 (25) liters of fresh water.

**12.12 Automatic filling of the cooling lubricant tank (optional)**

The automatic filling functions are only available in conjunction with automatic water filling (order No. 8550-1451-V01).

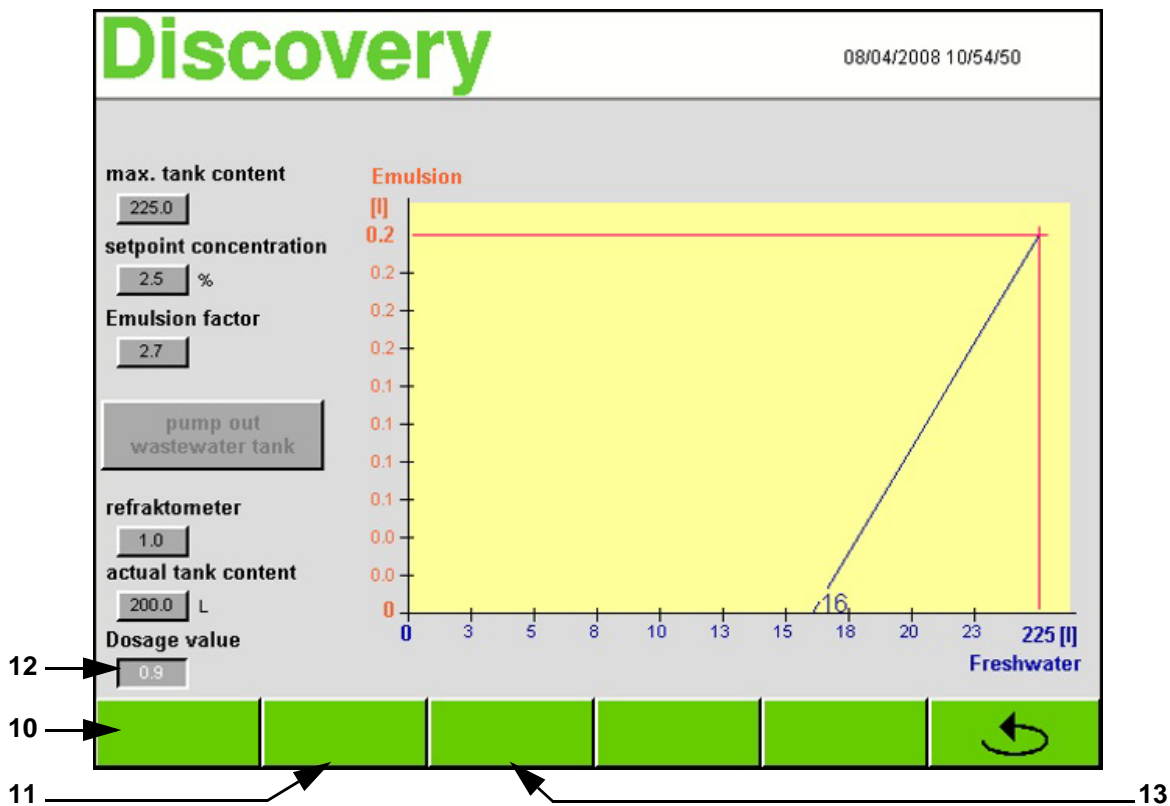

**Partial filling [10]**

- Pressing the "Partial filling" button will cause the cooling lubricant tank to be filled to a preset level.

If, for example, the error message "Cooling lubricant below minimum level, please fill!" is displayed, it can be partially filled during operation.

However, the cooling lubricant tank must be filled completely as soon as grinding work on the machine has been completed.

#### **Max. filling [11]**

Prior to automatic maximum filling of the cooling lubricant tank, the mixing ratio must be determined using the emulsion calculator ([see chapt. 12.11 Emulsion calculator, page 74](#)).

If an emulsion mixing device with a dosing unit (order No. 7019-1011-V02) is available, the dosage value [12] must be set. For automatic water filling, the calculated amount of emulsion must be filled into the cooling lubricant tank prior to filling.

#### **Stop filling [13]**

If the "Stop filling" button is pressed, automatic filling is immediately stopped.

## 13 Overview adjustment parameters



The following tables show the most important adjustment parameters with their adjustment areas and set values.

### 13.1 Adjustment parameters module STONE

|                     | Parameters        | Adjustment area<br>min. - max  | Standard set value   | Working range < set values  | Working range > set values   |
|---------------------|-------------------|--|--|---|--|
| <b>Stone unit</b>   |                   |  |  |   |  |
| Stone pre-grinding  | Stone processing  | 1-13   | 2-6  | < 2 only for structuring  | > 4 for extreme damages  |
|                     | Pre-grinding rpm  | 150-2000 rpm   | 500-700 rpm  | < 500 rpm less cutting  | > 700 rpm danger of damage to base due to heat   |
|                     | Pressure stone    | 50-500 N   | 260-320 N  | < 260 N less cutting  | > 320 N danger of damage by the stone  |
|                     | Structure         | Linear structure<br>Cross structure<br>Diagonal cross structure right<br>Diagonal cross structure left<br>Arrow structure<br>V-structure<br>Wave structure | Linear structure<br>Cross structure<br>Diagonal cross structure right<br>Diagonal cross structure left | Crossed and diagonal crossed structures have good rotary features - best for average skiers | Linear structure has good guiding features at high speed, but has an influence on the rotary features. So this structure should only be used for skilled skiers. |
|                     | Dressing speed    | 3-35 mm/sec.   | 16-20 mm/sec.  | 16 mm/sec. for dry snow   | 20 mm/sec. for wet snow  |
|                     | Dressing rpm      | 600-2000 rpm   | 1000   | < 1600 rpm too rough structure  |  |
| Stone fine-grinding | Stone processing  | 1-13   | 1  |   |  |
|                     | Fine-grinding rpm | 150-2000 rpm   | 350-450 rpm  | < 350 bigger structure distance   | > 450 rpm deteriorates structure image   |
|                     | Pressure stone    | 50-500 N   | 280-340 N  | < 280 N less cutting  | > 340 N danger of damage by the stone  |
|                     | Structure         | Linear structure<br>Cross structure<br>Diagonal cross structure right<br>Diagonal cross structure left<br>Arrow structure<br>V-structure<br>Wave structure | Linear structure<br>Cross structure<br>Diagonal cross structure right<br>Diagonal cross structure left | Crossed and diagonal crossed structures have good rotary features - best for average skiers | Linear structure has good guiding features at high speed, but has an influence on the rotary features. So this structure should only be used for skilled skiers. |
|                     | Dressing speed    | 3-35 mm/sec.   | 16-20 mm/sec.  | 16 mm/sec. for dry snow   | 20 mm/sec. for wet snow  |
|                     | Dressing rpm      | 600-2000 rpm   | 1600-2000 rpm  | < 1600 rpm too rough structure  |  |
| <b>Disc unit</b>    |                   |  |  |   |  |

|             | Parameters        | Adjustment area<br>min. - max | Standard set value | Working range < set values   | Working range > set values             |
|-------------|-------------------|-------------------------------|--------------------|--|--|
| SE grinding | SE processing     | 1-13                          | 1-2                | 1 process for slightly damaged skis<br>2 processes for normal damage and<br>3 processes for extreme damage                           |  |
|             | Pre-grinding rpm  | 1500-4500 rpm                 | 3800-4000 rpm      | <3800 rpm less cutting   | > 4000 rpm deteriorates grinding image |
|             | Fine-grinding rpm | 1500-4500 rpm                 | 3000 rpm           |  |  |
|             | Pressure SE       | 5-75 N                        | 50-75 N            | < 50 N less cutting  |  |
|             | Initial point SE  | -100-50mm                     | 0                  | Use for rental skis to vary the initial point of the SE processing.  |  |
| BE grinding | BE processing     | 1-13                          | 1                  | only 1 grinding process necessary  |  |
|             | Pre-grinding rpm  | 1500-4500 rpm                 | 3800-4000 rpm      | <3800 rpm less cutting   | > 4000 rpm deteriorates grinding image |
|             | Fine-grinding rpm | 1500-4500 rpm                 | 3000 rpm           |  |  |
|             | Pressure BE       | 5-65 Nm                       | 40-50 N            | < 40 N structure in edge   | > 50 N grinding on the base            |
|             | Initial point BE  | -100-50mm                     | 0                  | Use for rental skis to vary the initial point of the SE processing.<br>This function can also be used for carving skis if necessary. |  |

## 14 Maintenance - service

### 14.1 General

#### 14.1.1 Cleaning the inside of the machine



To prevent corrosion, always use the cleaning pipe and coolant when cleaning the machine!

The following points must be observed when cleaning the unit with the doors open:

- Main switch must be switched on
- Press stop key
- After approx. 15 seconds respectively after announcement on the display the sliding door can be opened.
- Start window is displayed on the screen



- Close the central stop valve ([see chapt. 6.3 Operating elements module STONE, page 23](#))
- Press key [1] to activate the cleaning pump.
- Switch off cleaning pump by actuating key [2].
- If the stationary grinding stone is sprayed over with the cleaning hose when the machine is cleaned, the grinding stone should be spin-dried by pressing the button [3] (risk of unbalance).



Close the doors beforehand!



14.1.2 Maintenance base machine - coolant tank - charging/discharging

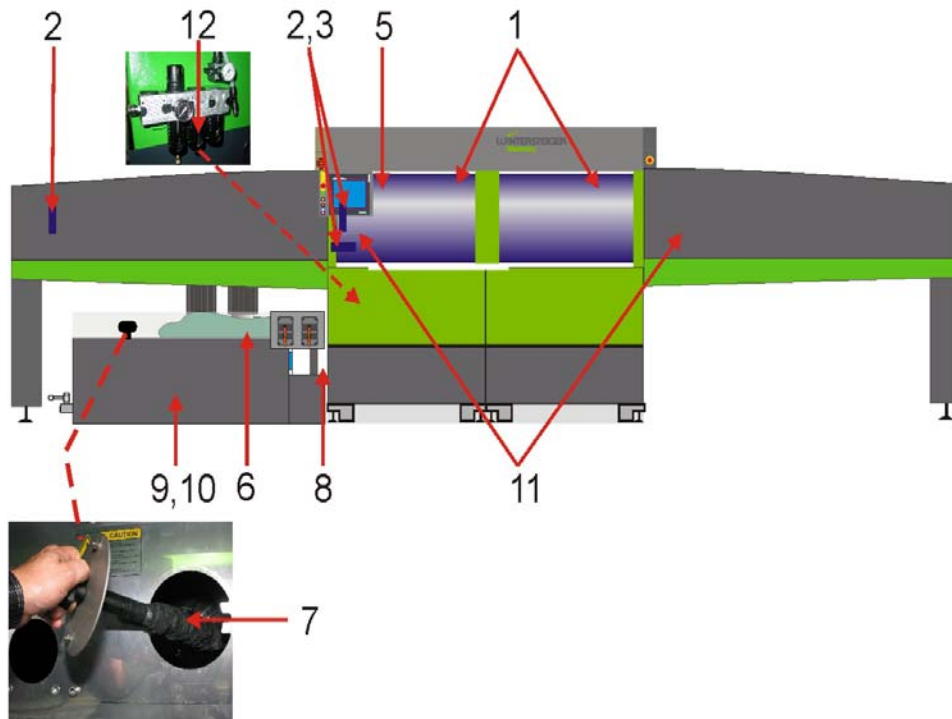

| Pos. no.              | Maintenance works                           | daily | weekly | every 2 <sup>nd</sup> week | monthly | annually | Comments   |
|-----------------------|---|-------|--------|----------------------------|---------|----------|--|
| <b>Cleaning</b>       |   |       |        |                            |         |          |  |
| 1)*                   | Whole machine outside and inside            | x     |        |                            |         |          | Clean sealing lips before closing and mounting covers  |
| 2)                    | Photoelectric barriers                      | x     |        |                            |         |          |  |
| 3)                    | Laser                                       |       | x      |                            |         |          |  |
| 4)                    | Support rollers and centering rollers       |       | x      |                            |         |          |  |
| 5)                    | Surface Touch Display                       | x     |        |                            |         |          | When the machine is switched off - with a damp cloth - do not use cleaning agent                                     |
| <b>Coolant system</b> |   |       |        |                            |         |          |  |
| 6)                    | Check filter bag and clean it, if necessary | x     |        |                            |         |          | more often if necessary  |
| 7)                    | Clean the bar magnet                        | x     |        |                            |         |          | Remove the bar magnet from the cooling agent container and clean using a cloth (carry out frequently when required). |

| Pos. no.             | Maintenance works   | daily | weekly | every 2 <sup>nd</sup> week | monthly | annually | Comments  |
|----------------------|---|-------|--------|----------------------------|---------|----------|---|
| 8)                   | Check coolant level   |       | x      |                            |         |          | more often if necessary   |
| 9)                   | Check pH-value and mixing ratio   |       | x      |                            |         |          | suitable measuring instrument available   |
| 10)                  | Change coolant  |       |        |                            | x       |          | see <a href="#">chapt. General indications for proper dealing with lubricating coolant</a><br>Mixing ratio: see indications of tank   |
| <b>Miscellaneous</b> |   |       |        |                            |         |          |   |
| 11)                  | Check function of safety flaps  |       |        | x                          |         |          | Remove ski magazines ( <a href="#">see chapt. 6.2 Operating elements ski magazine, page 21</a> )<br>Actuate safety flap with an object (e.g. ski) when the machine is switched on. Machine must automatically switch to emergency-stop! |
| 12)                  | Check compressor tank and maintenance unit for condensation; empty if necessary |       | x      |                            |         |          |   |
| 13)                  | Service by WINTERSTEIGER Customer Service                                       |       |        |                            |         | x        | Wear and tear cannot be avoided! Expert maintenance and inspection prevents and protects against failures and consequential damages!  |

\* Danger of corrosion: Do not use tap water for cleaning the machine! Use cleaning hose and coolant only!  
Do not clean the machine with a high-pressure cleaner! In the event that this instruction is not adhered, WINTERSTEIGER will refuse any liability and guarantee for any damage caused.

### 14.1.3 Emergency release of the sliding doors

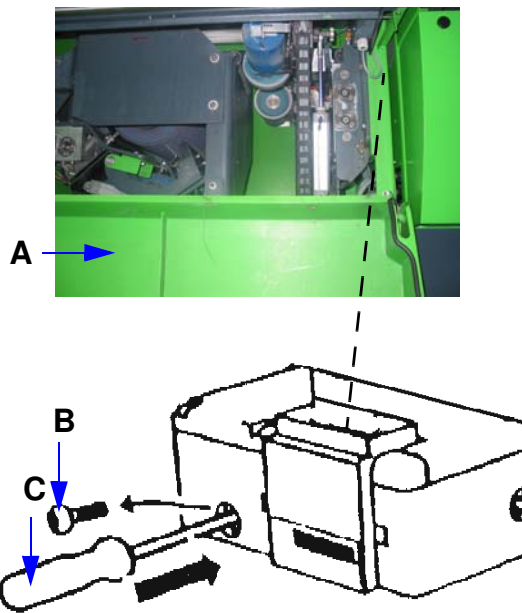

Opening with the emergency release is exclusively allowed when the voltage drops (if necessary) or when the door switch is defective.

- Open the bottom cover [A] of the respective sliding door.
- Remove screw [B] with TORX screwdriver.
- By pressing the holder [C] Ø2.5mm (0.098 in) and pulling the sliding door it can be opened.



After opening the sliding door, screw the screw (B) into the safety tumbler.

### 14.1.4 Clean laser

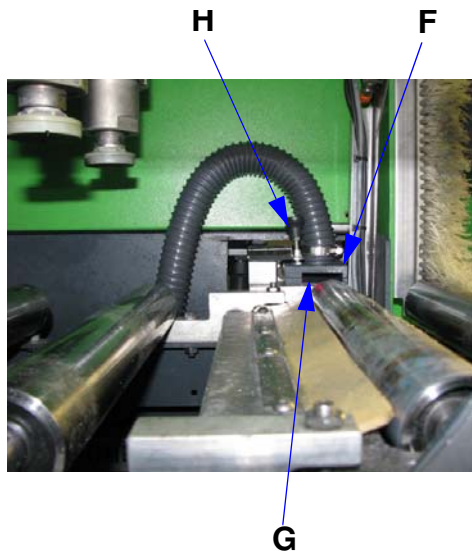

The laser must be cleaned once a week to guarantee correct ski measurements!



Do not spray the laser with the cleaning pipe!

- Switch the machine to cleaning mode ([see chapt. 14.1.1 Cleaning the inside of the machine, page 80](#))
- Remove ski magazine of charging ([see chapt. 6.2 Operating elements ski magazine, page 21](#))



**CAUTION** Risk of eye injuries!

Attention - do not look into the laser!

- Strip the fastening screw of the laser cover.
- Remove laser cover [F] by lifting it.

- Clean the laser glass [G] with a soft cloth and window agent.
- Put on the laser cover [F] again - considering the position holes!
- Tighten the fastening screw.

#### 14.1.5 Battery change on the operating panel

The battery must be changed within one week, if the information "Battery empty" is shown in the message line on the operating terminal.

The operating life of the battery is approx. 5 years under normal conditions, reduced however by higher temperatures.



**Always have a new battery ready!**

**If the battery is not changed in time, the complete adjustment values could be deleted.**

Battery change as follows:

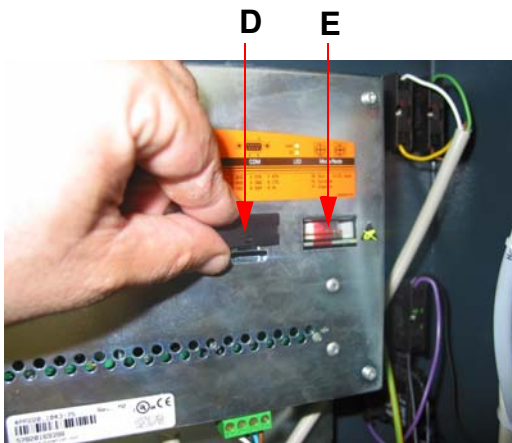

- Switch off main switch.
- If the service voltage was not switched on yet, switch it on for one minute at least and then off again.
- Open the rear cover of the operating panel by removing 2 screws.
- Remove battery cover [D].
- Remove battery [E] and plug-in new battery immediately (part no. 15-480-106)



**The battery change must be done within 5 minutes to avoid an overrun of data on the SPS-control.**

**Do not touch the battery with pliers or bare tweezers --> Short circuit! Only touch the battery at the ends.**

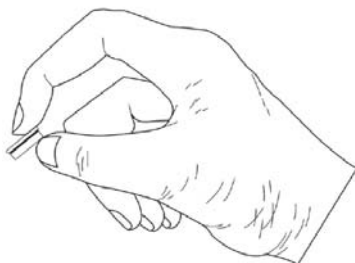

**Lithium batteries have to be disposed as hazardous waste! Used batteries must therefore be disposed of accordingly.**

### 14.1.6 General indications for proper dealing with lubricating coolant

To comply with its job of lubricating coolant (cooling, lubrication, removal of cutting, corrosion protection) lubricating coolant includes a lot of different chemical substances. So the corresponding maintenance and care of the lubricating coolant is very important.

#### Organizational steps



**Please pay special attention to having clean coolant to avoid formation of nitrosamines and germs!**

#### Please note following indications:

- Introduction of inorganic and organic food, remains of cigarettes, anticorrosive-agent cleaner, etc.
- Avoid admission of oil impurities to cooling system
- Avoid introduction of foreign substance which contains secondary amines or release them (more than 0.2 % in the cooling lubricant concentrate) e.g. cleanser, certain anticorrosive agent, system cleanser.

Following inspections and measurements have to be carried out. In Austria and Germany the TRGS 611 form the legal grounds for the limiting value. Other countries the limiting values have to be respected according customary laws.

| Inspection                      | Measuring interval | Limiting value                 |
|---------------------------------|--------------------|--------------------------------|
| KSS-Concentration               | weekly             | see indication of manufacturer |
| Nitrate level deposit water     | from time to time  | max. 50 mg/l                   |
| pH-factor                       | weekly             | 8.5 - 9.0                      |
| Nitrite                         | weekly             | max. 20 mg/l                   |
| Germination index (recommended) | monthly            | 10 <sup>6</sup> germs          |
| Total hardness                  | if required        | ca. 16°d                       |

Within the scope of FLUID MANAGEMENT WINTERSTEIGER offers analysis equipment for control and measurement of lubricating coolant as well as documentation of the test results. When overranging the limiting values you are able to place countermeasures immediately to extend the intervals for changing the coolant by 4 weeks essentially. WINTERSTEIGER-fluid management also includes additional products (high quality lubricating spray, system cleanser, machine foam cleanser, preservative agent, skin protection set) which are coordinated with the emulsion and so avoid an introduction of foreign substance to a great extent.

When overranging the limiting values please place corresponding countermeasures or change the coolant. As a result of non-application of WINTERSTEIGER-fluid management the emulsion has to be changed after approx. 1000 pair of ski or at the latest after 4 weeks. After the season and a longer standstill of the machine drain the cooling system and clean it with the system cleanser.

#### Protective measures

As lubricating coolants are, among other things, irritants, we recommend wearing corresponding protective clothing (e.g. gloves, safety goggles, fluid-repellent clothes). If you were not able to avoid contact with skin please use preventive skin protection (barrier cream).

#### Disposal

Take care that nothing gets into the sewage system. Duly, dispose according to the indications of the manufacturer in the general safety and prevailing regulations is essential.

## 14.2 Maintenance - service module STONE

### 14.2.1 Changing the grinding stone

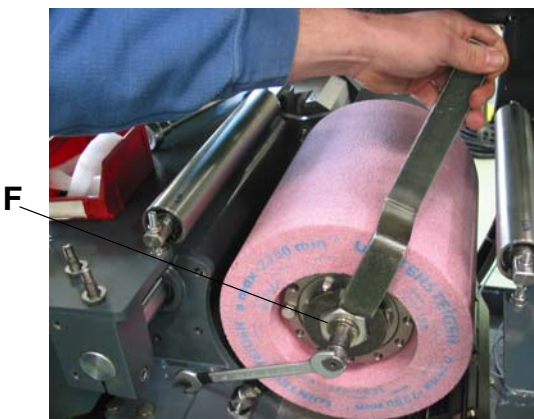
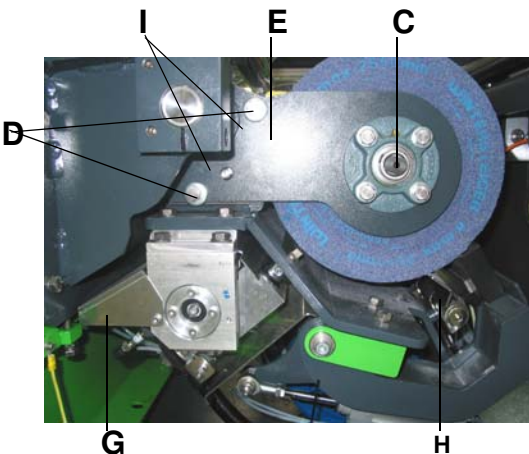
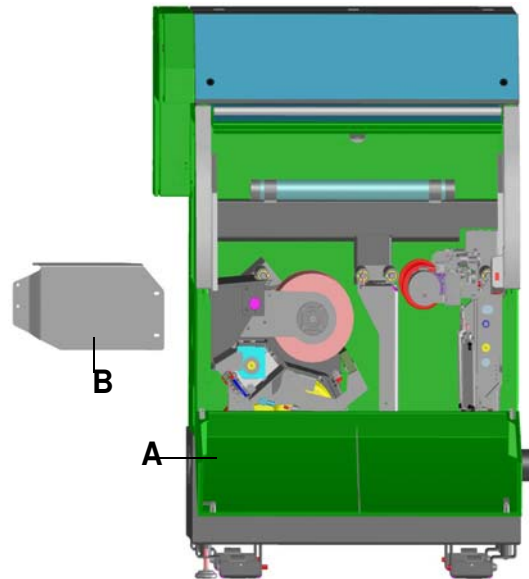

**Stone unit has to be in changing position before changing the stone** ([see chapt. 10.4.5 Manual functions stone unit, page 57](#))!

- Press stop key.
- The sliding door can be opened after approx. 15 seconds.
- Switch off main switch.
- Cut off compressed air ([see chapt. 5.1.1.1 Cut off compressed air, page 18](#)).
- Open bottom cover [A] and demount cover [B] before removing the stone.
- Loosen 2 headless pins [C] on the flange bearing.
- Remove two dowel screws [D] on the stone support [E]. If necessary, loosen the threaded bolt of the stone support [I] by screwing in hexagon socket screws.
- Detach the stone support [E].
- Hold with key (SW24) on shaft and loosen nut [F] with key (SW55).
- Pull off grinding stone.



**Clean and lubricate drive spindle!**

- Turn back the distance sheet for the stone spraying completely.
- Turn back the diamond completely with ratched wheel [G].
- Place new grinding stone onto drive spindle.



**Be sure to check new grinding stone for damage from transport.**

- Screw on nut [F] at grinding stone.
- Mount stone support [E] with 2 dowel screws [D].
- Tighten the 2 headless pins [C] at flange bearing.
- Set the distance from the distance sheet for the stone spraying [H] to the stone to 1-3 mm.



**Adjust the diamond as described in [chapt. Changing the diamond!](#)**

- Mount cover [B] again and close bottom cover [A].
- Open compressed air supply on the maintenance unit again after closing all covers.
- Carry out test run ([see chapt. 14.2.4 Carry out test run according to official regulations, page 88](#)).



**After the grinding stone has been replaced, check and if necessary, correct the stone diameter! ([see chapt. 10.4.6 Check and adapt stone diameter, page 58](#)).**

### 14.2.2 Changing the diamond

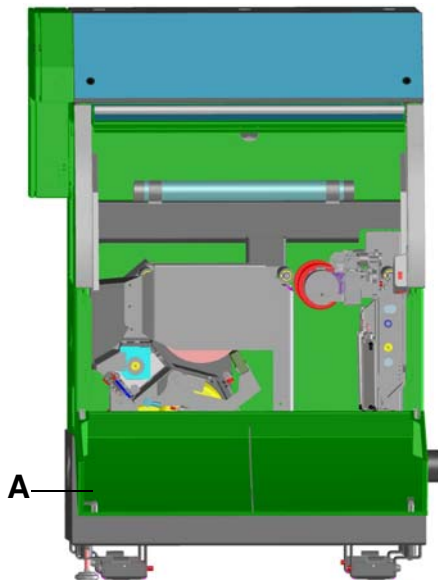

**Diamond has to be in changing position before changing it ([see chapt. 10.4.5 Manual functions stone unit, page 57](#))!**

- Press stop key.
- The sliding door can be opened after approx. 15 seconds.
- Switch off main switch.
- Cut off compressed air ([see chapt. 5.1.1.1 Cut off compressed air, page 18](#)).
- Open bottom cover [A].
- If necessary, turn the dresser block [B] completely to the outside by a hexagon socket key SW4 [C].
- Loosen hexagon socket screw [D], remove dressing diamond and clean borehole. Install and tighten new diamond with well lubricated shaft up to the limit stop.



**Screw must be pressed against end face of diamond shaft.**



C

D

- Turn back dressing diamond with ratchet wheel [E] (distance stone to diamond approx. 2 mm, 0.08 in).
- Turn in dressing carriage [B] with hexagon socket key SW4 [C] up to the position where the diamond projects over the grinding stone.
- Turn the stone slowly by hand.
- Turn the diamond with the ratchet wheel [E] until there is a contact on the stone.
- Close bottom cover [A] and sliding door.
- Switch on main switch - press start key.

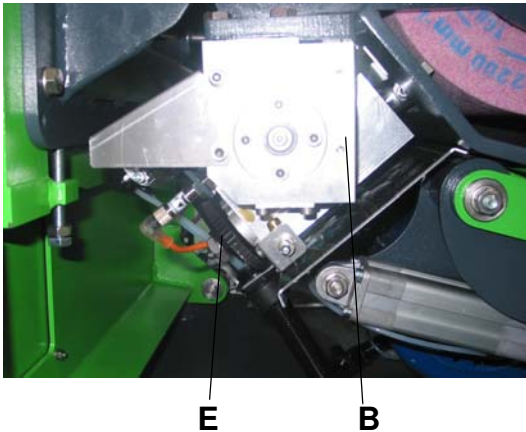

- Actuate key "DRESS" until the stone runs smoothly (at least 5x).



After changing the diamond check the diameter of the grinding stone and correct it, if necessary ([see chapt. 10.4.6 Check and adapt stone diameter, page 58](#))!

- Open compressed air supply on the maintenance unit again after closing all covers.

### 14.2.3 Changing the ceramic discs

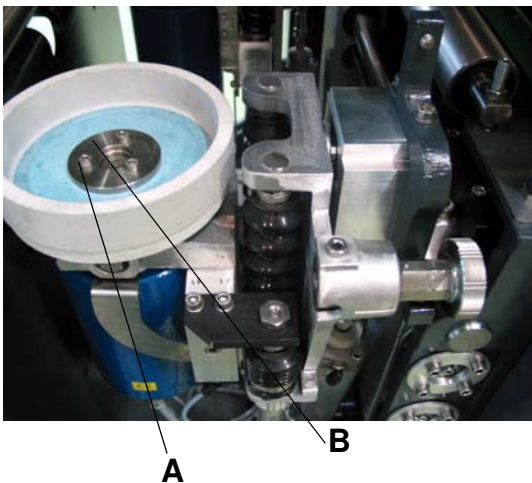

Before changing the ceramic discs, move the unit to the changing position ([see chapt. 10.5.2 Manual functions disc unit, page 63](#))!

- Press Emergency Stop key.
- The sliding door can be opened after approx. 15 seconds.
- Switch off main switch.
- Cut off compressed air ([see chapt. 5.1.1.1 Cut off compressed air, page 18](#)).
- Remove 3 hexagon socket head screws [A].
- Remove the ceramic disc.
- Clean flange and grease it with water-insoluble grease!
- Attach new ceramic disc (check new ceramic disc for damages from transport).
- Fit flange [B] and fix ceramic disc with hexagon socket head screws [A].
- Open compressed air supply on the maintenance unit again after closing all covers.
- Carry out test run ([see chapt. 14.2.4 Carry out test run according to official regulations, page 88](#)).

### 14.2.4 Carry out test run according to official regulations



A test must be performed for every grinding device with an outer diameter of more than 100 mm (3.94 in) before being used for the first time and after every retightening.

This test shall be conducted with no load, at the highest allowable peripheral speed and in the presence of



an expert. All grinding machines must be run for at least one minute. The test run may be performed only after all protective devices have been mounted and no one is standing in the danger zone. The grinding device may be used only after a flawless test run.

### 14.2.5 Maintenance works

| Pos. no.           | Maintenance works  | daily | weekly | every 2 <sup>nd</sup> week | monthly | annually | Comments  |
|--------------------|--|-------|--------|----------------------------|---------|----------|---|
| <b>Cleaning</b>    |  |       |        |                            |         |          |   |
| 1)*                | Whole module(s) outside and inside   | x     |        |                            |         |          | Clean sealing lips before closing and mounting covers   |
| <b>Lubrication</b> |  |       |        |                            |         |          |   |
| 2)                 | Grease guides disc unit  |       | x      |                            |         |          | 1 press stroke with grease per lubricator nipple  |
| 3)                 | Grease flange bearings of stone unit   |       |        |                            |         | x        | 1 press stroke with grease per lubricator nipple after season. Then turn on the machine again with closed central stop valves |
| 4)                 | Grease guides of dressing device   |       | x      |                            |         |          | 1 press stroke with grease per lubricator nipple  |
| 5)                 | Check the distance between the distance sheet of the stone spraying and the stone and adjust it, if needed; distance to the grinding stone about 1-3 m |       |        | x                          |         |          | clean if necessary  |

\* Danger of corrosion: Do not use tap water for cleaning the machine! Use cleaning hose and coolant only! Do not clean the machine with a high-pressure cleaner! In the event that this instruction is not adhered, WINTERSTEIGER will refuse any liability and guarantee for any damage caused.

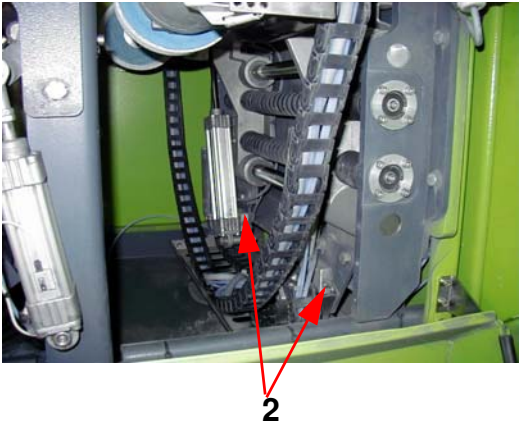
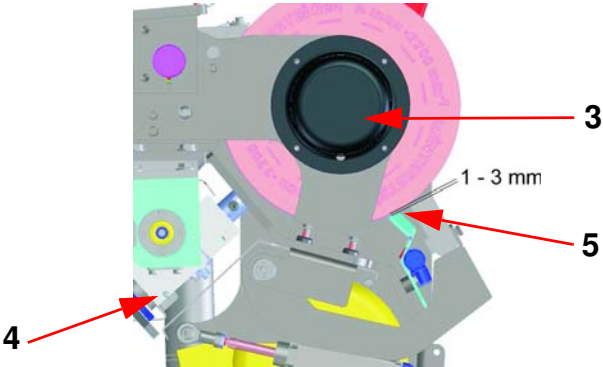

### 14.3 Maintenance schedule

| Maintenance works   | Month |   |   |   |   |   |   |   |   |    |    |    |    |    |    |    |    |    |    |    |    |    |    |    |    |    |    |    |    |    |    |  |  |
|---|-------|---|---|---|---|---|---|---|---|----|----|----|----|----|----|----|----|----|----|----|----|----|----|----|----|----|----|----|----|----|----|--|--|
|   | 1     | 2 | 3 | 4 | 5 | 6 | 7 | 8 | 9 | 10 | 11 | 12 | 13 | 14 | 15 | 16 | 17 | 18 | 19 | 20 | 21 | 22 | 23 | 24 | 25 | 26 | 27 | 28 | 29 | 30 | 31 |  |  |
| <b>daily</b>  |       |   |   |   |   |   |   |   |   |    |    |    |    |    |    |    |    |    |    |    |    |    |    |    |    |    |    |    |    |    |    |  |  |
| Clean whole machine outside and inside  |       |   |   |   |   |   |   |   |   |    |    |    |    |    |    |    |    |    |    |    |    |    |    |    |    |    |    |    |    |    |    |  |  |
| Check filter bag and clean it, if necessary                                     |       |   |   |   |   |   |   |   |   |    |    |    |    |    |    |    |    |    |    |    |    |    |    |    |    |    |    |    |    |    |    |  |  |
| Clean photoelectric barriers and laser  |       |   |   |   |   |   |   |   |   |    |    |    |    |    |    |    |    |    |    |    |    |    |    |    |    |    |    |    |    |    |    |  |  |
| Clean surface touch display   |       |   |   |   |   |   |   |   |   |    |    |    |    |    |    |    |    |    |    |    |    |    |    |    |    |    |    |    |    |    |    |  |  |
| <b>weekly</b>   |       |   |   |   |   |   |   |   |   |    |    |    |    |    |    |    |    |    |    |    |    |    |    |    |    |    |    |    |    |    |    |  |  |
| Lubricate flange bearing of belt unit   |       |   |   |   |   |   |   |   |   |    |    |    |    |    |    |    |    |    |    |    |    |    |    |    |    |    |    |    |    |    |    |  |  |
| Lubricate guides of disc unit   |       |   |   |   |   |   |   |   |   |    |    |    |    |    |    |    |    |    |    |    |    |    |    |    |    |    |    |    |    |    |    |  |  |
| Check coolant level   |       |   |   |   |   |   |   |   |   |    |    |    |    |    |    |    |    |    |    |    |    |    |    |    |    |    |    |    |    |    |    |  |  |
| Check pH-value and mixing ratio   |       |   |   |   |   |   |   |   |   |    |    |    |    |    |    |    |    |    |    |    |    |    |    |    |    |    |    |    |    |    |    |  |  |
| Check wear of stone cleaning block  |       |   |   |   |   |   |   |   |   |    |    |    |    |    |    |    |    |    |    |    |    |    |    |    |    |    |    |    |    |    |    |  |  |
| Check wear of diamond   |       |   |   |   |   |   |   |   |   |    |    |    |    |    |    |    |    |    |    |    |    |    |    |    |    |    |    |    |    |    |    |  |  |
| Clean support and centering rollers   |       |   |   |   |   |   |   |   |   |    |    |    |    |    |    |    |    |    |    |    |    |    |    |    |    |    |    |    |    |    |    |  |  |
| Check compressor tank and maintenance unit for condensation; empty if necessary |       |   |   |   |   |   |   |   |   |    |    |    |    |    |    |    |    |    |    |    |    |    |    |    |    |    |    |    |    |    |    |  |  |
| <b>every 2nd week</b>   |       |   |   |   |   |   |   |   |   |    |    |    |    |    |    |    |    |    |    |    |    |    |    |    |    |    |    |    |    |    |    |  |  |
| Check distance of spraying nozzles and adjust it, if necessary                  |       |   |   |   |   |   |   |   |   |    |    |    |    |    |    |    |    |    |    |    |    |    |    |    |    |    |    |    |    |    |    |  |  |
| Check function of safety flap   |       |   |   |   |   |   |   |   |   |    |    |    |    |    |    |    |    |    |    |    |    |    |    |    |    |    |    |    |    |    |    |  |  |
| <b>monthly</b>  |       |   |   |   |   |   |   |   |   |    |    |    |    |    |    |    |    |    |    |    |    |    |    |    |    |    |    |    |    |    |    |  |  |
| Change coolant  |       |   |   |   |   |   |   |   |   |    |    |    |    |    |    |    |    |    |    |    |    |    |    |    |    |    |    |    |    |    |    |  |  |
| <b>after season</b>   |       |   |   |   |   |   |   |   |   |    |    |    |    |    |    |    |    |    |    |    |    |    |    |    |    |    |    |    |    |    |    |  |  |
| Service by WINTERSTEIGER Technical Service                                      |       |   |   |   |   |   |   |   |   |    |    |    |    |    |    |    |    |    |    |    |    |    |    |    |    |    |    |    |    |    |    |  |  |
| Lubricate flange bearing of stone unit with 1 press stroke with grease          |       |   |   |   |   |   |   |   |   |    |    |    |    |    |    |    |    |    |    |    |    |    |    |    |    |    |    |    |    |    |    |  |  |



Please copy before use!

## 15 Shut-down and disposal

**WARNING****Risk of injury!**

**Disconnect the machine from the mains supply or any external drive prior to shutting down and dismantling. Use only suitable tools for dismantling.**



**When shutting down the machine dismantle and dispose of all machine parts properly. Clean all oily and greasy components prior to disposal.**

**Oil and grease should never be allowed to pollute the environment.**

**Ensure that all disposal regulations specific to your country are adhered to!**

- Dismantle the machine properly into its individual components.
- Clean oily and greasy components.
- Dispose of components by material group (steel, plastic, electrical and electronic components, etc.).
- Dispose of oil and grease in an environmentally friendly manner.

**CE Konformitätserklärung**  
**Declaration of Conformity**  
**Certificat de conformité**  
**Declaración de conformidad**  
**Dichiarazione di conformità**



Hiermit erklären wir, dass das Produkt:

We hereby declare that this product...

Par la présente nous certifions que le dit produit:

Por la presente declaramos que el producto:

Con la presente dichiariamo che il prodotto:

**Discovery**

**No.:**

**S/SS/SSS/PS/PSS/PSF/PSSF/SF/SSF/SSSF**

**Steinschleifautomat/Automated Stone Grinder**

folgender(-en) einschlägigen Bestimmung(en) entspricht

conforms to the following regulations:

correspond à la (aux) spécification(s) suivante(s)

corresponde a la(s) siguiente(s) directiva(s) competente(s)

è conforme alla(e) seguente(i) disposizione(i)

**EG-Maschinenrichtlinie 2006/42/EG**

**EG-EMV-Richtlinie 2004/108/EG**

**EG-Niederspannungsrichtlinie 2006/95/EG**

Dokumentations-Bevollmächtigter:

Person authorised to compile the technical file:

Personne autorisée à constituer le dossier technique:

Persona facultada para elaborar el expediente técnico:

Persona autorizzata a costituire il fascicolo tecnico:

Mag. Gottfried Aschauer

WINTERSTEIGER AG

A-4910 Ried / I., Dimmelstraße 9

Ried /I., am 13.01.2010



Ing. Walter Aumayr  
Vorstand



Mag. Gottfried Aschauer  
CE-Beauftragter